

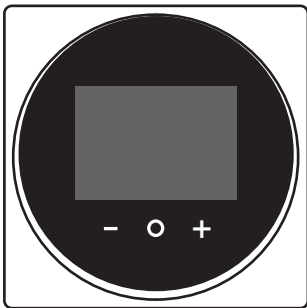

Installer and user reference guide

Madoka wired remote controller



BRC1H82W
BRC1H82K
BRC1H82S

Table of contents

1	About the documentation	5
1.1	About this document	5
1.2	Meaning of warnings and symbols	6
1.3	Installer and user reference guide at a glance	6
2	General safety precautions	8
2.1	For the installer	8
2.2	For the user	9
3	Specific installer safety instructions	10
For the user		11
4	Remote controller: Overview	12
4.1	About the controller	12
4.2	Buttons	13
4.3	Status icons	13
4.4	Status indicator	15
5	Operation	16
5.1	Basic usage	16
5.1.1	Home screen	16
5.1.2	Main menu	17
5.2	Operation mode	18
5.2.1	About the operation modes	19
5.2.2	To set the operation mode	23
5.3	Setpoint	23
5.3.1	About the setpoint	24
5.3.2	To set the setpoint	26
5.4	Date and time	26
5.4.1	About date and time	26
5.4.2	To set date and time	27
5.5	Airflow	27
5.5.1	Airflow direction	27
5.5.2	Fan speed	28
5.6	Ventilation	30
5.6.1	Ventilation mode	30
5.6.2	Ventilation rate	31
5.7	Advanced usage	31
6	Maintenance and service	32
6.1	Overview: Maintenance and service	32
7	Troubleshooting	33
7.1	Overview: Troubleshooting	33
7.2	Refrigerant leak detection	33
7.2.1	About refrigerant leak detection	33
7.2.2	To stop the leak detection alarm	34
For the installer		35
8	About the box	36
8.1	To unpack the controller	36
9	Preparation	37
9.1	Wiring requirements	37
9.1.1	To prepare the wiring for installation	37
10	Installation	38
10.1	Overview: Installation	38
10.2	Mounting the controller	38
10.2.1	About mounting the controller	38
10.2.2	To mount the controller	39
10.3	Connecting the electrical wiring	40
10.3.1	Precautions when connecting the electrical wiring	40

10.3.2	To connect the electrical wiring.....	40
10.4	Closing the controller.....	41
10.4.1	Precautions when closing the controller	41
10.4.2	To close the controller	41
10.5	Opening the controller	42
10.5.1	Precautions when opening the controller	42
10.5.2	To open the controller	42
11	Starting up the system	43
11.1	Controller designation	43
11.1.1	To designate a controller as slave.....	44
12	Remote controller: Overview	45
12.1	About the controller	45
12.1.1	To configure the controller	46
12.2	Buttons	46
12.3	Status icons	47
12.4	Status indicator	48
12.4.1	Behaviour.....	48
13	Operation	50
13.1	Basic usage.....	50
13.1.1	Screen backlight	50
13.1.2	Home screen.....	51
13.1.3	Information screen	52
13.1.4	Main menu.....	53
13.2	Operation mode.....	54
13.2.1	About the operation modes.....	54
13.2.2	To set the operation mode	58
13.3	Setpoint.....	58
13.3.1	About the setpoint	59
13.3.2	To set the setpoint	61
13.4	Date and time.....	61
13.4.1	About date and time	61
13.4.2	To set date and time.....	62
13.5	Airflow	62
13.5.1	Airflow direction	62
13.5.2	Fan speed.....	63
13.6	Ventilation.....	65
13.6.1	Ventilation mode.....	65
13.6.2	Ventilation rate.....	66
13.7	Advanced usage	66
14	Configuration	67
14.1	Installer menu	67
14.1.1	About the installer menu	67
14.1.2	Screen settings	68
14.1.3	Status indicator settings.....	69
14.1.4	Field settings.....	69
14.1.5	Miscellaneous settings	76
14.2	Software update	89
14.2.1	About software updates.....	89
14.2.2	Software update with app.....	89
14.2.3	Software update with updating tool.....	90
15	About the app	92
15.1	Operation and configuration overview	93
15.2	Pairing.....	93
15.2.1	About pairing	93
15.2.2	To pair the app with a controller	93
15.2.3	To make a Bluetooth connection.....	94
15.2.4	To terminate the Bluetooth connection	96
15.2.5	To remove bonding information	97
15.3	User access levels.....	99
15.3.1	About user access levels.....	99
15.3.2	Basic mode.....	99
15.3.3	Advanced mode.....	99
15.3.4	Installer mode.....	100
15.4	Demo mode	101
15.4.1	About demo mode	101
15.4.2	To launch demo mode.....	101

15.4.3	To exit demo mode	101
15.5	Functions	101
15.5.1	Overview: Functions	101
15.5.2	Remote controller firmware update	104
15.5.3	Notifications	104
15.5.4	Master/slave status	104
15.5.5	Screen	104
15.5.6	Status indicator	105
15.5.7	Date and time	105
15.5.8	About	106
15.5.9	Remove bonding information	106
15.5.10	Presence detection	106
15.5.11	OFF timer	107
15.5.12	Energy consumption	107
15.5.13	Power consumption limit	107
15.5.14	Setpoint auto reset	107
15.5.15	Schedule	108
15.5.16	Holiday	108
15.5.17	Setpoint logic	109
15.5.18	Setback	110
15.5.19	Individual airflow direction	111
15.5.20	Active airflow circulation	112
15.5.21	Setpoint range	112
15.5.22	Cooling/Heating masterhood	112
15.5.23	Airflow direction range	113
15.5.24	Draught prevention	113
15.5.25	Quick start	113
15.5.26	External input interlock	114
15.5.27	Defrost operation	114
15.5.28	Function lock	114
15.5.29	Quiet mode	116
15.5.30	Errors and warnings	116
15.5.31	Unit number	116
15.5.32	Filter auto clean	117
15.5.33	Filter notifications	117
15.5.34	AirNet address	117
15.5.35	Group address	117
15.5.36	Field settings	118
15.5.37	Duty rotation	119
15.5.38	Test operation	120
15.5.39	Unit status	122
15.5.40	Operating hours	122
15.5.41	Contact information	122
15.5.42	Active airflow circulation	122
15.5.43	Setting migration	122
15.5.44	Supervised room address	123
15.5.45	Refrigerant leak alarm test	123
16	Maintenance	124
16.1	Maintenance safety precautions	124
16.2	About maintenance	124
16.3	To remove a warning screen	126
16.4	To clean the controller	126
16.5	Time to clean filter indication	126
16.5.1	To remove the Time to clean filter indication	126
17	Troubleshooting	127
17.1	Error codes of the indoor unit	127
17.2	Refrigerant leak detection	129
17.2.1	About refrigerant leak detection	129
17.2.2	To stop the leak detection alarm	129
18	Technical data	131
18.1	Connection diagram	131
18.1.1	Typical layout	131
18.1.2	Typical layout for group control	131
18.1.3	Controller + DIII central control equipment	133
19	Glossary	134

1 About the documentation

In this chapter

1.1	About this document.....	5
1.2	Meaning of warnings and symbols.....	6
1.3	Installer and user reference guide at a glance.....	6

1.1 About this document

Target audience

Authorised installers + end users

Documentation set

This document is part of a documentation set. The complete set consists of:

- **Installation and operation manual:**
 - Installation instructions
 - Basic operation instructions
- **Installer and user reference guide:**
 - Extended installation and operation information
- **Declaration of conformity:**



INFORMATION: Declaration of conformity

Hereby, Daikin Europe N.V. declares that the radio equipment type BRC1H is in compliance with the Directive 2014/53/EU. The original declaration of conformity is available from the BRC1H product pages.

The documentation set is available from the BRC1H product pages:

- BRC1H82W: <https://qr.daikin.eu/?N=BRC1H82W>



- BRC1H82K: <https://qr.daikin.eu/?N=BRC1H82K>

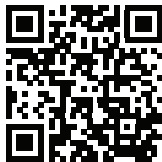

- BRC1H82S: <https://qr.daikin.eu/?N=BRC1H82S>





INFORMATION: Madoka Assistant in-app documentation

The controller only allows for basic settings and operation. Advanced settings and operation are performed via the Madoka Assistant app. For more information, see the app and its in-app documentation. The Madoka Assistant app is available from Google Play and the Apple Store.

Latest revisions of the supplied documentation may be available on the regional Daikin website or via your dealer.

The original documentation is written in English. All other languages are translations.

1.2 Meaning of warnings and symbols



DANGER

Indicates a situation that results in death or serious injury.



DANGER: RISK OF ELECTROCUTION

Indicates a situation that could result in electrocution.



WARNING

Indicates a situation that could result in death or serious injury.



CAUTION

Indicates a situation that could result in minor or moderate injury.



NOTICE

Indicates a situation that could result in equipment or property damage.



INFORMATION

Indicates useful tips or additional information.



DANGER: RISK OF EXPLOSION

Indicates a situation that could result in explosion.

1.3 Installer and user reference guide at a glance

Chapter	Description
About the documentation	What documentation exists for the installer and the user
General safety precautions	Safety instructions that you must read before installing
Specific installer safety instructions	Safety instructions that the installer must read before installing
For the user	

Chapter	Description
Remote controller: Overview	Overview of the remote controller
Operation	How to operate the remote controller
Maintenance and service	How to maintain and service the remote controller
Troubleshooting	What to do in case of problems
For the installer	
About the box	How to unpack the remote controller and remove the accessories
Preparation	What to do and know before going on-site
Installation	What to do and know to install the remote controller
Starting up the system	How to start up the remote controller
Remote controller: Overview	Overview of the remote controller
Configuration	What to do and know to configure the system after it is installed
About the app	What to do and know to commission the remote controller after it is configured
Maintenance	How to maintain the remote controller
Troubleshooting	What to do in case of problems
Technical data	Specifications of the system
Glossary	Definition of terms

2 General safety precautions

In this chapter

2.1	For the installer.....	8
2.2	For the user.....	9

2.1 For the installer

The precautions described in this document cover very important topics, follow them carefully.



INFORMATION

This controller is an option and cannot be used standalone. Also see the installation and operation manual of the indoor and outdoor units.



WARNING

Improper installation or attachment of equipment or accessories could result in electrical shock, short-circuit, leaks, fire or other damage to the equipment. Only use accessories, optional equipment and spare parts made or approved by Daikin.



WARNING

All field wiring and components **MUST** be installed by a licensed electrician and **MUST** comply with the applicable legislation.



NOTICE

The remote controller **MUST** be mounted indoors.



NOTICE

When the controller is used as room thermostat, select an installation location where the average temperature in the room can be detected.

Do NOT install the controller in the following places:

- In places where it is exposed to direct sunlight.
- In places where it is near a heat source.
- In places that are affected by outside air or air draught due to e.g. door opening/closing.
- In places where the display can easily get dirty.
- In places where there is NO easy access to the controls.
- In places with temperatures $<-10^{\circ}\text{C}$ and $>50^{\circ}\text{C}$.
- In places where the relative humidity is $>95\%$.
- In places where there is machinery that emits electromagnetic waves. Electromagnetic waves may disturb the control system, and cause malfunction of the equipment.
- In places where it may be exposed to water, or in generally moist areas.

If you are NOT sure how to install or operate the unit, contact your dealer.

After finishing installation:

- Conduct a trial operation to check for faults.
- Explain the user how to operate the controller.
- Ask the user to store the manual for future reference.

**INFORMATION**

Consult your dealer regarding the relocation and reinstallation of the controller.

2.2 For the user

**WARNING**

To clean the controller, do NOT use organic solvents, such as paint thinner.

**WARNING**

Do NOT use flammable materials (e.g. hairspray or insecticide) near the controller.

**WARNING**

To prevent electric shocks or fire:

- Do NOT operate the controller with wet hands.
- Do NOT disassemble the controller and touch interior parts. Contact your dealer.
- Do NOT modify or repair the controller. Contact your dealer.
- Do NOT relocate or reinstall the controller by yourself. Contact your dealer.

**WARNING**

Do NOT play with the unit or its remote controller. Accidental operation by a child may result in impairment of bodily functions and harm health.

3 Specific installer safety instructions

Always observe the following safety instructions and regulations.



CAUTION

Never touch the internal parts of the controller.



CAUTION

When closing the controller, be careful not to pinch the wiring.



CAUTION

Before starting up the system, make sure:

- The indoor and outdoor unit wiring is completed.
- The switch box covers of the indoor and outdoor units are closed.



CAUTION

When connecting the controller to the indoor unit, make sure the indoor unit switchbox and transmission wiring are not connected.



WARNING

All field wiring and components **MUST** be installed by a licensed electrician and **MUST** comply with the applicable legislation.



WARNING

Before carrying out any maintenance or repair activities, stop system operation with the controller, and turn off the power supply circuit breaker. **Possible consequence:** electric shock or injury.



WARNING

Do not wash the remote controller. **Possible consequence:** electric leakage, electric shock, or fire.

For the user

4 Remote controller: Overview

In this chapter

4.1	About the controller	12
4.2	Buttons	13
4.3	Status icons	13
4.4	Status indicator	15

4.1 About the controller





Depending on configuration, the controller is operable in either one of three modes. Each mode offers different controller functionality.

Mode	Functionality
Normal	<p>The controller is fully functional.</p> <p>All functionality described under "5 Operation" [▶ 16] is available.</p> <p>The controller can be a master or a slave controller.</p>
Alarm only	<p>The controller only acts as leak detection alarm for a single indoor unit.</p> <p>No functionality described under "5 Operation" [▶ 16] is available.</p> <p>For information on the leak detection alarm, see "7.2 Refrigerant leak detection" [▶ 33].</p> <p>The controller can be a master or a slave controller.</p>
Supervisor	<p>The controller only acts as leak detection alarm for the whole system, i.e. multiple indoor units and their respective controllers. This mode is intended for a controller that is to be used in a supervision location, e.g. the reception desk of a hotel.</p> <p>No functionality described under "5 Operation" [▶ 16] is available.</p> <p>For information on the leak detection alarm, see "7.2 Refrigerant leak detection" [▶ 33].</p> <p>The controller can only be a slave controller.</p>

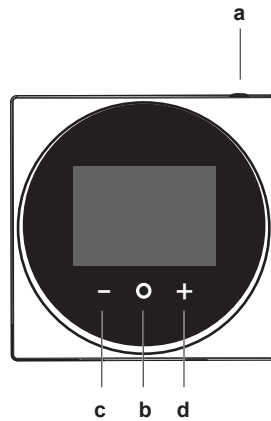





For more information on how to set the controller to be operable in a specific mode, see ["To configure the controller"](#) [▶ 46]. When using "Supervisor" mode, it is important to set the supervised room address in order to know for which indoor unit the refrigerant leak alarm occurs. See ["Supervised room address"](#) [▶ 123] for more information.

4.2 Buttons



















- a  ON/OFF
 - When OFF, press to turn ON the system.
 - When ON, press to turn OFF the system.
- b  ENTER/ACTIVATE /SET
 - From the home screen, enter the main menu.
 - From the main menu, enter one of the submenus.
 - From their respective submenu, activate an operation/ventilation mode.
 - In one of the submenus, confirm a setting.
- c  CYCLE/ADJUST
 - Cycle left.
 - Adjust a setting (default: decrease).
- d  CYCLE/ADJUST
 - Cycle right.
 - Adjust a setting (default: increase).

4.3 Status icons

Icon	Description
	System operation ON. Indicates that the system is in operation.
	System operation OFF. Indicates that the system is NOT in operation.
	Bluetooth. ⁽¹⁾ Indicates that the controller is communicating with a mobile device, for use with the Madoka Assistant app.
	Lock. Indicates that a function or operation mode is locked and therefore cannot be used or selected.
	Centralised control. Indicates that the system is controlled by central control equipment (optional accessory) and that control of the system by the controller is limited.
	Changeover under centralised control. Indicates that the cooling/heating changeover is under centralised control by another indoor unit, or by an optional cool/ heat selector that is connected to the outdoor unit.

⁽¹⁾ The Bluetooth® word mark and logos are registered trademarks owned by the Bluetooth SIG, Inc. and use of such marks by Daikin Europe N.V. is under license. Other trademarks and trade names are those of their respective owners.

Icon	Description
	Defrost/Hot start. Indicates that the defrost/hot start mode is active.
	Schedule/Timer. Indicates that the system operates according to a schedule, or that the OFF timer is enabled.
	Time not set. Indicates that controller's time is not set.
	Self-cleaning filter operation. Indicates that self-cleaning filter operation is active.
	Quick Start. Indicates that Quick Start mode is active (Sky Air only).
	Test operation. Indicates that Test Operation mode is active (Sky Air only).
	Inspection. Indicates that the indoor or outdoor unit is being inspected.
	Periodic inspection. Indicates that the indoor or outdoor unit is being inspected.
	Backup. Indicates that in the system an indoor unit is set as backup indoor unit.
	Individual airflow direction. Indicates that the individual airflow direction setting is enabled.
	Information. Indicates that the system has a message to convey. To see the message, go to the information screen.
	Warning. Indicates that an error occurred, or that an indoor unit component needs to be maintained.
	Power consumption limit. Indicates that the system's power consumption is being limited, and that it is running with restricted capacity.
	End of power consumption limit. Indicates that the system's power consumption is no longer being limited, and that it is no longer running with restricted capacity.
	Rotation. Indicates that Rotation mode is active.
	Setback. Indicates that the indoor unit is operating under setback conditions.
	Ventilation. Indicates that a heat reclaim ventilation unit is connected.



INFORMATION

- For information on the operation mode and ventilation mode icons, see ["5.2 Operation mode" \[p. 18\]](#) and ["Ventilation mode" \[p. 30\]](#) respectively.
- Most icons are related to things set in the Madoka Assistant app. For more information, see the app.

4.4 Status indicator

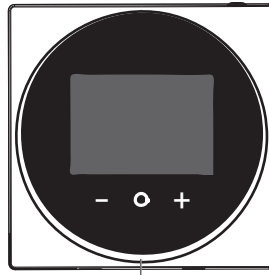

a

a Status indicator

5 Operation

In this chapter



5.1	Basic usage.....	16
5.1.1	Home screen	16
5.1.2	Main menu	17
5.2	Operation mode	18
5.2.1	About the operation modes.....	19
5.2.2	To set the operation mode	23
5.3	Setpoint.....	23
5.3.1	About the setpoint	24
5.3.2	To set the setpoint	26
5.4	Date and time	26
5.4.1	About date and time	26
5.4.2	To set date and time	27
5.5	Airflow.....	27
5.5.1	Airflow direction.....	27
5.5.2	Fan speed	28
5.6	Ventilation.....	30
5.6.1	Ventilation mode.....	30
5.6.2	Ventilation rate	31
5.7	Advanced usage	31

5.1 Basic usage

5.1.1 Home screen

Home screen mode

Depending on configuration, the controller either has a standard or a detailed home screen. While the standard home screen gives you only limited information, the detailed home screen gives you all kinds of information through status icons. After a period of operation inactivity, the controller will always revert to the home screen.

Standard	Detailed
	

Home screen operation

In certain conditions, the controller allows you to perform actions from the home screen.

Condition	Action
The system is running in Cooling, Heating, or Auto operation mode.	Change the setpoint 

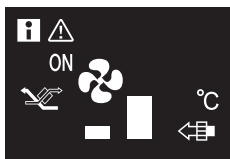
Condition	Action
The system is composed of ONLY heat reclaim ventilation units.	Change the ventilation rate 



INFORMATION





- Depending on configuration, the home screen displays the setpoint either as a numerical value, or as a symbol. For more information, see "[About the setpoint](#)" [▶ 24].
- In case the home screen displays the setpoint as a symbol, then it will only display the status icons of the standard home screen mode, even when the controller is in detailed home screen mode.









INFORMATION

The controller is equipped with a power saving function that causes the screen to go blank after a period of inactivity. To make the screen light up again, press one of the buttons.

5.1.2 Main menu

From the home screen, press  to enter the main menu. Use  and  to cycle through the menus. Press  again to enter one of the menus.

Menu	Description
	Operation mode. Set the operation mode.
	Date and time. Make date and time settings.
	Airflow direction. Set the indoor unit airflow direction.
	Fan speed. Set the indoor unit fan speed.
	Ventilation mode. Set the ventilation operation mode.
	Ventilation rate. Set the fan speed for ventilation operation.
	Bluetooth. Activate Bluetooth to control the system with the Madoka Assistant app, and/or to perform a remote controller software update.



INFORMATION

- Depending on the type of indoor unit you are operating, more or less menus may be available.
- In the main menu, the icon for each menu reflects the current active setting or mode. When operating the controller, the menu you navigate through can look different from that represented in this manual.
- The controller only allows for basic operation of the system. For advanced operation (setback, schedule timer, ...), see the Madoka Assistant app.



INFORMATION

It is possible that menus are locked. When this is the case, they appear crossed-out in the main menu, and get accompanied by a lock icon. The locking of functions happens through the Madoka Assistant app. For more information, see the Madoka Assistant app and "Function lock" [▶ 114].

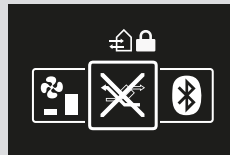

5.2 Operation mode

The indoor unit can operate in various operation modes.

Icon	Operation mode
	Cooling. In this mode, cooling will be activated as required by the setpoint, or by Setback operation.
	Heating. In this mode, heating will be activated as required by the setpoint, or by Setback operation.
	Fan Only. In this mode, air circulates without heating or cooling.
	Dry. In this mode, the air humidity will be lowered with a minimal temperature decrease. The temperature and fan speed are controlled automatically and cannot be controlled by the controller. Dry operation will not function if the room temperature is too low.
	Ventilation. In this mode, the space gets ventilated, but not cooled or heated.
	Air Clean. In this mode, the optional air cleaning unit operates.
	Ventilation + Air Clean. Combination of ventilation and air clean operation.
	Auto. In Auto mode, the indoor unit automatically switches between heating and cooling mode, as required by the setpoint.

**INFORMATION**

Depending on the indoor unit, more or less operation modes are available.

5.2.1 About the operation modes

**INFORMATION**

If the indoor unit is a cooling-only model, it can only be set to run in Cooling, Fan only, or Dry operation mode.

**INFORMATION**

When operation modes are not available in the operation mode menu, it is additionally possible that they are locked. The locking of operation modes occurs through the Madoka Assistant app. For more information, see the Madoka Assistant app and ["Function lock"](#) [▶ 114].

**INFORMATION**

If the operation mode changeover of an indoor unit is under centralised control ('changeover under centralised control' status icon blinking in the home screen), then it is NOT possible to change the operation mode of that indoor unit. For more information, see ["Cooling/Heating masterhood"](#) [▶ 86].

Cooling

If the outdoor air temperature is high, it can take some time until the indoor room temperature reaches the setpoint temperature.

When the indoor room temperature is low, and the indoor unit is set to run in Cooling operation mode, the indoor unit can enter Defrost operation mode first (i.e. Heating operation), this to prevent a decrease of the system's cooling capacity due to frost on the heat exchanger. For more information, see ["Heating"](#) [▶ 19].



The indoor unit can run in Cooling operation mode because it is operating under Setback conditions. For more information, see ["Setback"](#) [▶ 110].

Heating

When running in Heating operation mode, the system requires a longer time to reach the setpoint temperature than when running in Cooling operation mode. To make up for this, it is recommended to let the system start operation in advance by making use of the timer function.

The indoor unit can run in Heating operation mode because it is operating under Setback conditions. For more information, see ["Setback"](#) [▶ 110].

To prevent cold drafts and a reduction of the system's heating capacity, the system can run in the following special heating operation modes:

Operation	Description
Defrost	<p>To prevent the loss of heating capacity due to frost accumulation in the outdoor unit, the system will automatically switch to defrost operation.</p> <p>During defrost operation, the indoor unit fan will stop operation, and the following icon will appear on the home screen:</p>  <p>The system will resume normal operation after approximately 6 to 8 minutes.</p>
Hot start (VRV only)	<p>During hot start, the indoor unit fan will stop operation, and the following icon will appear on the home screen:</p> 

 **INFORMATION**

When the system is stopped while the indoor unit is running in Heating operation mode, the fan will continue to operate for approximately 1 minute, this to get out any heat remaining in the indoor unit.

 **INFORMATION**

- The lower the outdoor air temperature, the lower the heating capacity. If the system's heating capacity is insufficient, it is recommended to include another heating appliance into the setup (if you use a combustion appliance, ventilate the room regularly. Also, do not use the heating appliance in places where it is exposed to the airflow of the indoor unit).
- The indoor unit is of the hot air circulation type. As a result, after operation start, it takes the indoor unit some time to warm up the room.
- The indoor unit fan will automatically operate until the indoor temperature of the system rises to a certain level.
- When hot air stays under the ceiling and your feet feel cold, it is recommended to include a circulator into the setup.

Dry

 **NOTICE**

To prevent water leakage or system failure, do NOT turn off the system immediately after indoor unit operation. Before turning off the system, wait until the drain pump finishes discharging any water remaining in the indoor unit (approximately 1 minute).

 **INFORMATION**

To ensure a smooth start, do not turn off the system while it is operating.

Auto

**INFORMATION**

In case of indoor unit setpoint logic, the system cannot run in Auto operation mode. Therefore, to allow for Auto operation mode, go for remote controller setpoint logic. For more information, see the Madoka Assistant app and "Setpoint logic" [▶ 109].

The Auto operation mode logic depends on the set setpoint logic (Madoka Assistant app setting).

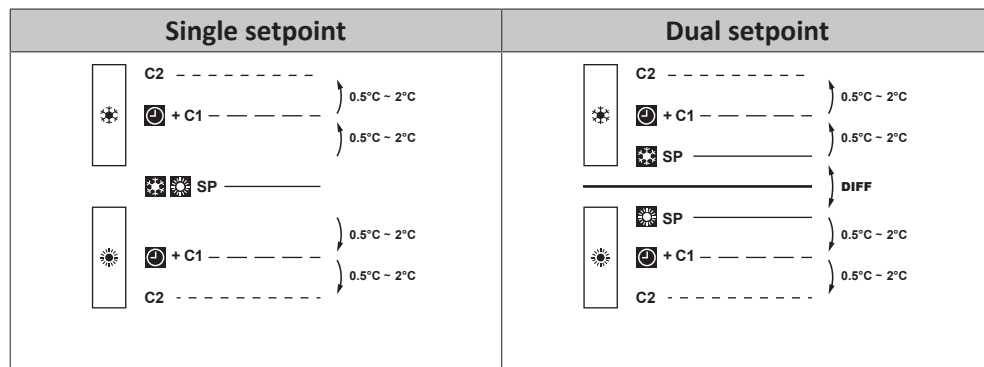

	Cooling setpoint
	Heating setpoint
DIFF	Minimum setpoint differential between the Heating and the Cooling setpoint
	Changeover setpoint (with guard timer)
C2	Forced changeover setpoint
0.5°C~2°C	Field settable temperature intervals between setpoints

**INFORMATION**

The default value of the settable temperature range (0.5°C~2°C) is 0.5°C.

A changeover from the one operation mode to the other occurs in the following cases:

Case 1: primary changeover (+C1)

A changeover occurs from the moment the room temperature rises above/drops below the Cooling/Heating changeover setpoint (C1), and the guard timer has run out.

Example:

Single setpoint	Dual setpoint
<p>C2 ----- 24°C + C1 ----- 23°C SP ----- 22°C +1°C</p> <p>C2 ----- 20°C + C1 ----- 21°C -1°C</p>	<p>C2 ----- 26°C + C1 ----- 25°C SP ----- 24°C +1°C DIFF: 2°C</p> <p>C2 ----- 20°C + C1 ----- 21°C SP ----- 22°C -1°C</p>
<p>The system is heating up the room. When after a while the room temperature rises above C1 (23°C), a changeover from Heating to Cooling occurs, provided that the guard timer has run out. If the guard timer has not run out, the changeover will only occur from the moment the timer does run out. As a result of the changeover, the guard timer starts running again so as to allow for or prevent the next changeover.</p> <p>The system is cooling down the room. When after a while the room temperature drops below C1 (21°C), a changeover from Cooling to Heating occurs, provided that the guard timer has run out. If the guard timer has not run out, the changeover will only occur from the moment the timer does run out. As a result of the changeover, the guard timer starts running again, to allow for or prevent the next changeover.</p>	<p>The system is heating up the room. When after a while the room temperature rises above C1 (25°C), a changeover from Heating to Cooling occurs, provided that the guard timer has run out. If the guard timer has not run out, the changeover will only occur from the moment the timer does run out. As a result of the changeover, the guard timer starts running again so as to allow for or prevent the next changeover.</p> <p>The system is cooling down the room. When after a while the room temperature drops below C1 (21°C), a changeover from Cooling to Heating occurs, provided that the guard timer has run out. If the guard timer has not run out, the changeover will only occur from the moment the timer does run out. As a result of the changeover, the guard timer starts running again, to allow for or prevent the next changeover.</p>

Case 2: forced changeover (C2)

A changeover is forced from the moment the room temperature rises above/drops below the Cooling/Heating forced changeover setpoint (C2) while the guard timer is still running.

Example:

Single setpoint	Dual setpoint
<p>The system is heating up the room. When the room temperature rises above C2 (24°C) while the guard timer is still running, a changeover is forced from Heating to Cooling.</p> <p>The system is cooling down the room. When the room temperature drops below C2 (20°C) while the guard timer is still running, a changeover is forced from Cooling to Heating.</p>	<p>The system is heating up the room. When the room temperature rises above C2 (26°C) while the guard timer is still running, a changeover is forced from Heating to Cooling.</p> <p>The system is cooling down the room. When the room temperature drops below C2 (20°C) while the guard timer is still running, a changeover is forced from Cooling to Heating.</p>



INFORMATION

To prevent operation mode changeovers from occurring too frequently, changeovers typically occur only after the guard timer has run out (i.e. Case 1). However, to prevent the room from getting too hot or too cold, a changeover is forced when the room temperature reaches C2 while the guard timer is still running (i.e. Case 2).

5.2.2 To set the operation mode

- 1 Navigate to the operation mode menu.



- 2 Use **-** and **+** to select an operation mode.

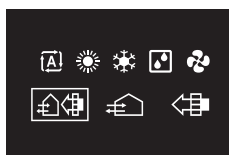

- 3 Press **OK** to activate.

Result: The indoor unit changes its operation mode and the controller returns to the home screen.

5.3 Setpoint

The setpoint is the target temperature for the Cooling, Heating, and Auto operation modes.

**INFORMATION**

The lower setpoint limit of the Cooling operation mode is 20°C, as per UAE Federal regulation UAE.S 5010-5:2016 clause 6, and UAE.S 5010-1:2016 clause 10.

5.3.1 About the setpoint

Depending on configuration, the home screen displays the temperature setpoint either as a numerical value, or as a symbol.

**INFORMATION**

For how to set the home screen setpoint, see the Madoka Assistant app. Also see "Screen" [▶ 104].

Home screen setpoint: Numerical

In case the home screen displays the temperature setpoint as a numerical value, you control the room temperature by raising or lowering the setpoint by 1°C increments.



The default setpoint range is 16°C~32°C. If any limitations are set to this range with the setpoint range function (Madoka Assistant app function; see "Setpoint range" [▶ 112]), it is only possible to raise or lower the setpoint up/down to the set maximum/minimum setpoint range limits.

Home screen setpoint: Symbolic

In case the home screen displays the temperature setpoint as a symbol, you control the room temperature by raising or lowering the setpoint in relation to the "reference setpoint" (visually indicated by the marker in the middle of the thermometer).



It is possible to raise the setpoint up to three steps of 1°C above and up to three steps of 1°C below the reference setpoint.

Example: if the reference setpoint is 25°C, it is possible to raise the setpoint to 28°C and lower it to 22°C.

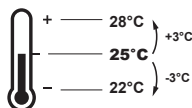
**INFORMATION**

For how to set the reference setpoint, see the Madoka Assistant app. Also see "Screen" [▶ 104].

Exceptions to this logic are possible in case of:

- Setpoint range limitations
- Central control / control by a schedule

Setpoint range

If any limitations are set to the default setpoint range (16°C~32°C) with the setpoint range function (Madoka Assistant app function; see "[Setpoint range](#)" [▶ 112]), it is only possible to raise or lower the setpoint up/down to the set upper/lower setpoint range limits.

Example: if the reference temperature is 25°C, you can normally lower the setpoint three steps to 22°C. However, if a setpoint range limit is set to 23°C, you can only lower the setpoint to 23°C.

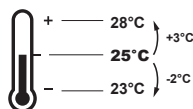

Central control / Schedule

If the system is under the control of a centralised controller or a schedule, then the regular +3°C/−3°C setpoint range limits can get overruled AND changed.

IF	THEN
The centralised controller or schedule imposes a setpoint that is within the regular +3°C/−3°C setpoint range.	Nothing unusual happens and the system follows the regular setpoint and setpoint range logic.

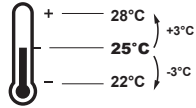
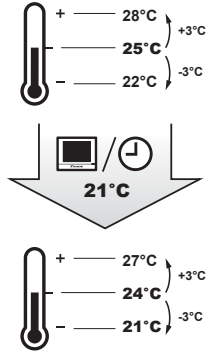
IF	THEN
<p>The centralised controller or schedule imposes a setpoint that exceeds the regular +3°C/-3°C setpoint range.</p>	<p>The imposed setpoint becomes the new upper/lower limit of the +3°C/-3°C range, and the whole range shifts in relation to this new limit.</p> <p>Example: the reference setpoint is set to 25°C, yielding the following setpoint range:</p>  <p>If the centralised controller or schedule changes the setpoint to 21°C, which is below the range, then "21°C" becomes the new lower limit, and the range shifts in relation to this new limit.</p> 

5.3.2 To set the setpoint

Prerequisite: The active operation mode is either 'Cooling', 'Heating', or 'Auto'.

- 1 In the home screen, use  and  to adjust the setpoint.





Result: The indoor unit changes its temperature setpoint.

5.4 Date and time

Set the date and time for the indoor units connected to the controller.

5.4.1 About date and time

Depending on daylight saving time settings, the date and time menu has the following daylight saving time indicators:

	Summer time
	Winter time

For more information, see "[Indoor unit field settings](#)" [▶ 73] (remote controller settings) and "[Date and time](#)" [▶ 105] (app settings).

5.4.2 To set date and time

- 1 Navigate to the date and time menu.

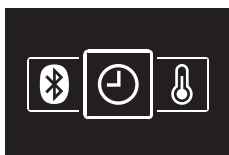

- 2 Press **+** to activate .

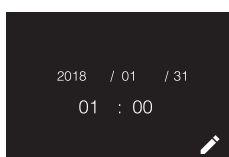

Result: The fields become editable.

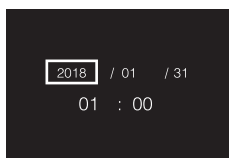

- 3 Set the date and time. Set with **-** and **+**. Confirm with **○**. Cycle through the menu until all fields are set correctly.

Result: You set the date and the time.



INFORMATION

Confirming the value in a field will automatically bring you to the next field. To finish making settings and leave the menu, navigate to and confirm the value in the last field.



5.5 Airflow

5.5.1 Airflow direction

The airflow direction is the direction in which the indoor unit blows its air.

About airflow direction

The following airflow directions can be set:

Direction	Screen
Fixed position. The indoor unit blows air in 1 of 5 fixed positions.	
Swing. The indoor unit alternates between the 5 positions.	
Auto. The indoor unit adjusts its airflow direction according to movement sensed by a movement sensor.	



INFORMATION

- Depending on the type of indoor unit, and/or on system layout and organisation, Auto airflow direction may not be available.
- For some types of indoor unit, you cannot set the airflow direction.

Automatic airflow control



In the following operating conditions, the airflow direction of the indoor units is controlled automatically:

- When the room temperature is higher than the controller's setpoint for Heating operation (including Auto operation).
- When the indoor units run in Heating operation mode, and the Defrost function is active.
- When the indoor units run in Continuous operation, and the airflow direction is Horizontal.

To set the airflow direction

- 1 Navigate to the airflow direction menu.



- 2 Use  and  to adjust the airflow direction.



- 3 Press  to confirm.



Result: The indoor unit changes its airflow direction and the controller returns to the home screen.

5.5.2 Fan speed

The fan speed is the strength of the airflow coming out of the indoor unit.

About fan speed

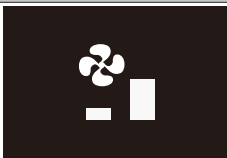
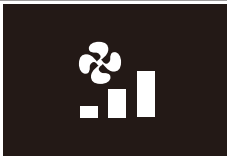
Depending on the indoor unit, you can choose between either:

Fan speed	Screen
2 fan speeds	
3 fan speeds	
5 fan speeds	

Some indoor units additionally support Automatic fan speed. In this case, the indoor unit adjusts its fan speed automatically, according to the setpoint and indoor temperature.

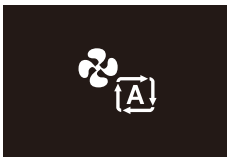
Fan speed	Screen
Automatic	





INFORMATION

- For mechanical protection purposes, it is possible that the indoor unit switches itself to 'Automatic fan speed' mode.
- If the fan stops operating, this does not necessarily mean system failure. The fan can stop operating at all times.
- It may take some time before changes made to fan speed settings are actually carried out.

To set the fan speed

- 1 Navigate to the fan speed menu.



- 2 Use  and  to adjust the fan speed.



- 3 Press  to confirm.

Result: The indoor unit changes its fan speed and the controller returns to the home screen.

5.6 Ventilation



INFORMATION

Ventilation settings can ONLY be made for heat reclaim ventilation units.

5.6.1 Ventilation mode

The heat reclaim ventilation unit can operate in various operation modes.

Icon	Ventilation mode
	Energy Reclaim Ventilation. The outdoor air is supplied to the room after passing through a heat exchanger.
	Bypass. The outdoor air is supplied to the room without passing through a heat exchanger.
	Auto. To ventilate the room in the most efficient way, the heat reclaim ventilation unit automatically switches between "Bypass" and "Energy Reclaim Ventilation" mode (based on internal calculations).



INFORMATION

Depending on the heat reclaim ventilation unit, more or less ventilation modes are available.



INFORMATION

Ventilation mode changes are possible regardless of Cooling/Heating masterhood. For more information, see "[Cooling/Heating masterhood](#)" [▶ 86].



NOTICE

Before starting up the system, the unit **MUST** be energised for at least 6 hours to avoid compressor breakdown during startup.



INFORMATION

To ensure a smooth start, do not turn off the system while it is operating.

To set the ventilation mode

- 1 Navigate to the ventilation mode menu.



- 2 Use and to select a ventilation mode.



- 3 Press to activate.

Result: The heat reclaim ventilation unit changes its operation mode and the controller returns to the home screen.

5.6.2 Ventilation rate

The ventilation rate is the fan speed during ventilation operation.

To set the ventilation rate

- 1 Navigate to the ventilation rate menu.



- 2 Use  and  to adjust the ventilation rate.

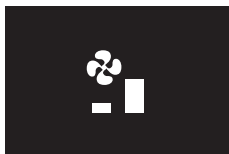

- 3 Press  to confirm.

Result: The heat reclaim ventilation unit changes its ventilation rate and the controller returns to the home screen.

5.7 Advanced usage

The controller only allows for basic operation. For advanced operation, use the Madoka Assistant app.





INFORMATION

To operate the controller with the app, you need to connect the controller to a mobile device on which the app is installed. For instructions, see ["15.2 Pairing" \[p.93\]](#).

6 Maintenance and service

6.1 Overview: Maintenance and service

When a system components needs maintenance or service, consult your dealer. To indicate that maintenance is due, the controller displays  on the home screen, and/or displays a warning screen as soon as you press  to enter the main menu from the home screen.

The following warning screens are related to indoor unit maintenance:

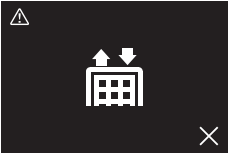
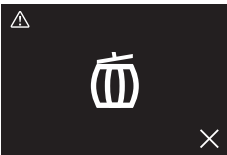

<p>Clean the indoor unit filter</p> 	<p>Replace the indoor unit filter</p> 
<p>Empty the indoor unit dustbox</p> 	<p>—</p>

7 Troubleshooting

In this chapter

7.1	Overview: Troubleshooting	33
7.2	Refrigerant leak detection	33
7.2.1	About refrigerant leak detection	33
7.2.2	To stop the leak detection alarm	34

7.1 Overview: Troubleshooting

When the system is in error, consult your dealer. To indicate system error, the controller displays  on the home screen, and/or displays an error screen as soon as you press  to enter the main menu from the home screen.

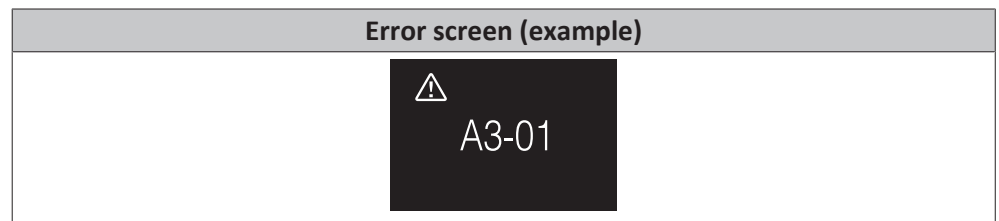

i **INFORMATION**

If the controller is set to be operable in "Supervisor" mode, then the controller adds the "supervised room address" of the faulty indoor unit to the error screen. In "Supervisor" mode, it is mandatory to set a unique "supervised room address" for every indoor unit. The "supervised room address" can be set in the Madoka Assistant app. Note that in case of multiple leakages, only the address of the first faulty unit rising the error is displayed.

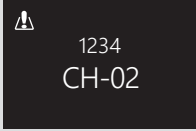

For more information about the modes the controller can be set to be operable in, see ["4.1 About the controller" \[12\]](#).

7.2 Refrigerant leak detection

When the system detects a refrigerant leak, an alarm goes off. Stop the alarm and consult your dealer.

i **INFORMATION**

For more information on what to do in the app in case of a refrigerant leak, see ["15 About the app" \[92\]](#).

7.2.1 About refrigerant leak detection

The information that the controller displays in case of a refrigerant leak depends on the mode that the controller is set to be operable in.

Normal and Alarm only mode

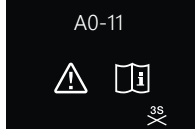
Master controller	Slave controller
The controller displays the unit number of the leaking indoor unit 	The controller does not display the unit number of the leaking indoor unit 

Supervisor mode

Master controller	Slave controller
—	The controller displays the supervised room address of the leaking indoor unit 

**INFORMATION**

For more information about the modes, see ["4.1 About the controller" \[p. 12\]](#).

7.2.2 To stop the leak detection alarm

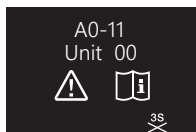

- 1 Press **+** for 3 seconds to stop the alarm.

Result: The alarm stops.

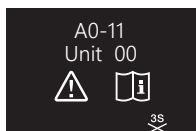

- 2 Consult your dealer.

**INFORMATION**

In case the controller is set to be operable in 'Supervisor' mode, the controller will indicate the supervised room address of the indoor unit for which the leak detection alarm occurs. However, it is not possible to stop the alarm of the indoor unit controller (set to be operable in either "Normal" or "Alarm only" mode) from the controller in "Supervisor" mode. The alarm of the controller connected to the indoor unit with the leak has to be stopped individually.

For the installer

8 About the box

8.1 To unpack the controller

- 1 Open the box.
- 2 Separate the accessories.

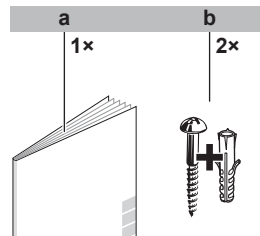

- a Installation and operation manual
- b Wood screws + wall plugs (Ø4.0x30)

9 Preparation

9.1 Wiring requirements

All wiring must comply with the following requirements:

Wire specification	Value
Type	Sheathed vinyl cord or cable (2 wires)
Section	0.75~1.25 mm ²
Maximum length	500 m

9.1.1 To prepare the wiring for installation

- 1 Peel the sheath of the part of the cable that needs to pass through the inside of the rear casing (L), according to the figure and the table.
- 2 Keep a 10 mm distance between the length of the 2 wires.

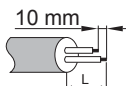

Wiring outlet	L
Top	±150 mm
Left	±120 mm
Bottom	±100 mm
Rear	No requirements

10 Installation

In this chapter

10.1	Overview: Installation.....	38
10.2	Mounting the controller.....	38
10.2.1	About mounting the controller.....	38
10.2.2	To mount the controller.....	39
10.3	Connecting the electrical wiring.....	40
10.3.1	Precautions when connecting the electrical wiring.....	40
10.3.2	To connect the electrical wiring.....	40
10.4	Closing the controller.....	41
10.4.1	Precautions when closing the controller.....	41
10.4.2	To close the controller.....	41
10.5	Opening the controller.....	42
10.5.1	Precautions when opening the controller.....	42
10.5.2	To open the controller.....	42

10.1 Overview: Installation

The installation of the controller typically consists of the following stages:

- 1 Determining how you want to route the electrical wiring, and nipping away a piece of the rear casing accordingly.
- 2 Mounting the rear casing to the wall.
- 3 Connecting the electrical wiring.
- 4 Closing the controller.

10.2 Mounting the controller

10.2.1 About mounting the controller

Before you can mount the controller, you have to determine the wiring routing, and accordingly, remove a piece of the controller's rear casing.

The wiring can be routed from the top, the rear, the left, or the bottom. Remove a piece of the rear casing according to the illustration:

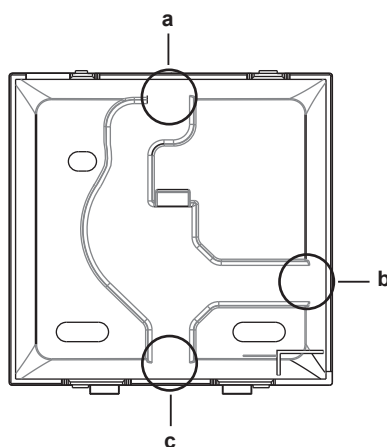

- a** Wiring from the top
- b** Wiring from the left
- c** Wiring from the bottom

In case you are routing the wiring from the rear, you do not have to remove anything.



INFORMATION

When routing the wiring from the top or from the rear, insert the wiring through the knockout hole before mounting the rear casing to the wall.

10.2.2 To mount the controller

- 1 Take the screws and plugs from the accessory bag.
- 2 Mount the rear casing to a flat surface.

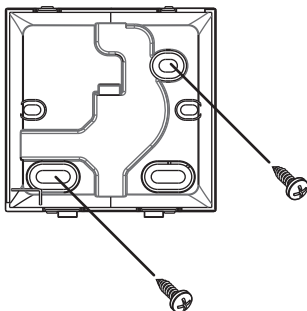

INFORMATION

If required (e.g. when mounting to a flush-mounted electrical installation box), mount the rear casing by way of the knockout holes.

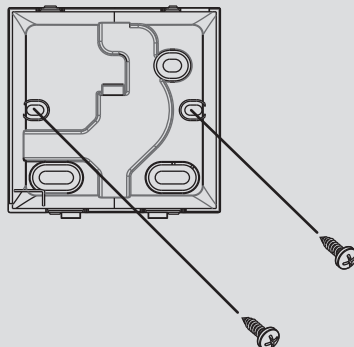

NOTICE

When mounting the rear casing to a flush-mounted electrical installation box inside a wall, make sure that that wall is completely flat.



NOTICE

Be careful not to distort the rear casing by overtightening the mounting screws.

10.3 Connecting the electrical wiring

10.3.1 Precautions when connecting the electrical wiring



INFORMATION

Also read the precautions and requirements in the following chapters:

- General safety precautions
- Preparation



WARNING

All field wiring and components **MUST** be installed by a licensed electrician and **MUST** comply with the applicable legislation.



CAUTION

When connecting the controller to the indoor unit, make sure the indoor unit switchbox and transmission wiring are not connected.



NOTICE

The wiring for connection is **NOT** included.



NOTICE

When wiring, run the wiring away from the power supply wiring in order to avoid receiving electric noise (external noise).



INFORMATION

P1 and P2 have no polarity.

10.3.2 To connect the electrical wiring

Connect controller terminals P1/P2 to indoor unit terminals P1/P2.

From the top

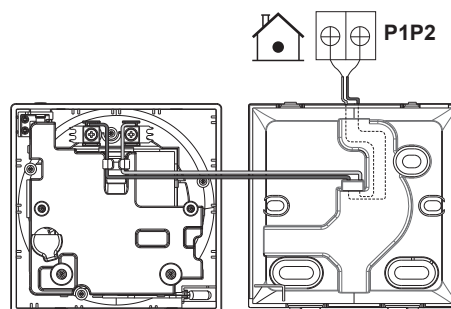

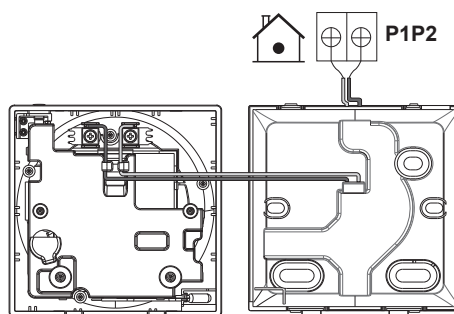
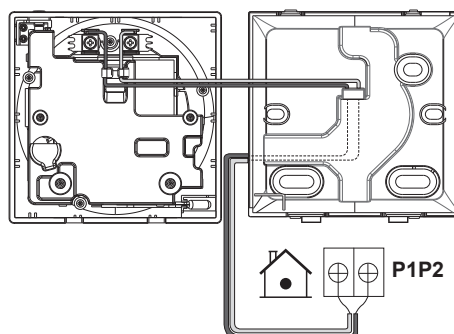
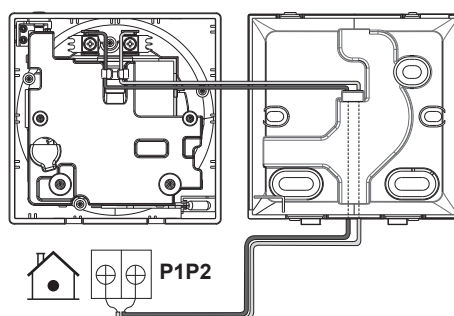
From the rear**From the left****From the bottom**

10.4 Closing the controller

10.4.1 Precautions when closing the controller

**CAUTION**

Never touch the internal parts of the controller.

**CAUTION**

When closing the controller, be careful not to pinch the wiring.

**NOTICE**

To prevent damage, make sure the front of the controller is clicked into the rear casing securely.

10.4.2 To close the controller

- 1 Click the front of the controller into the rear casing.

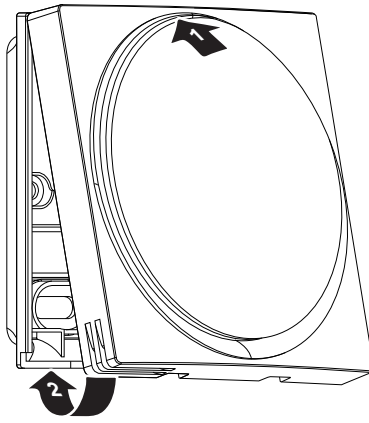

- 2 When the installation site is dust-free, peel off the protective seal.

10.5 Opening the controller

10.5.1 Precautions when opening the controller



NOTICE

The controller PCB is mounted into the front casing. When opening the controller, be careful not to damage the PCB.



NOTICE

When the front and rear casing are separated, make sure the PCB does not come into contact with dust or moisture.

10.5.2 To open the controller

- 1 Insert a flat-head screwdriver into one of the bottom closing mechanisms and slowly twist it.

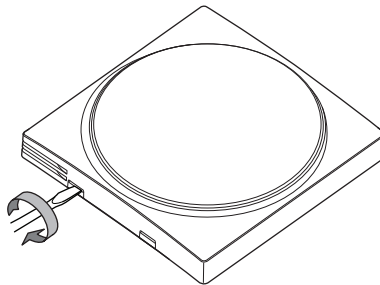

11 Starting up the system



CAUTION

Before starting up the system, make sure:

- The indoor and outdoor unit wiring is completed.
- The switch box covers of the indoor and outdoor units are closed.

The controller gets its power from the indoor unit. It will start up as soon as it is connected. For the controller to be operable, make sure the indoor unit is powered on.

Once the controller is powered, it will automatically start up. If it is the first and only controller that is connected to the indoor unit, it will automatically get designated as a "Normal" master controller.

11.1 Controller designation

Once started up, designate the controller to be operable in "Normal", "Alarm only", or "Supervisor" mode, and designate it as either a master or a slave controller. If a controller is set to be operable in "Supervisor" mode, it can only be a slave controller.

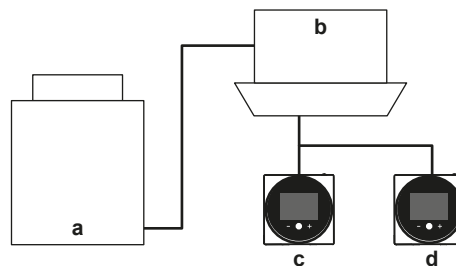

- a Outdoor unit
- b Indoor unit
- c Master remote controller
- d Slave remote controller

On the information screen, master/slave status is indicated by the following icons:

Icon	Description
	Master
	Slave

For more information, see ["Information screen" \[▶ 52\]](#).



INFORMATION

It is only possible to use a master and a slave controller of the same type.



INFORMATION

In case digital input adapter BRP7A5* is part of the system, it is not possible to connect and designate a second controller. Connecting a second controller when the system already contains the adapter, will cause the adapter to go in error.



INFORMATION

If the slave controller does not display the home screen two minutes after its designation, turn off the power and check the wiring.



INFORMATION

After re-designating a controller, the system requires a power reset.



INFORMATION

Slave controllers do not support all functions. If you cannot find a function on a slave controller, check for it on the master controller.



INFORMATION

For master and slave controllers to function together, they need to have the same value for the "Home screen setpoint" setting (Madoka Assistant app setting), i.e. all set to "Numerical" or all set to "Symbolic".

11.1.1 To designate a controller as slave

Prerequisite: A master controller is already connected to the indoor unit.

- 1 Connect a second controller.

Result: It will start up automatically.

- 2 Wait for a U5 or U8 error to appear on the screen.



- 3 When the U5 or U8 error appears, press  and keep it pressed until "2" appears on the screen.



Result: The controller is now designated as slave.

12 Remote controller: Overview

In this chapter

12.1	About the controller	45
12.1.1	To configure the controller	46
12.2	Buttons	46
12.3	Status icons	47
12.4	Status indicator	48
12.4.1	Behaviour	48

12.1 About the controller

Depending on configuration, the controller is operable in either one of three modes. Each mode offers different controller functionality.

Mode	Functionality
Normal	<p>The controller is fully functional.</p> <p>All functionality described under "13 Operation" [▶ 50] is available.</p> <p>The controller can be a master or a slave controller.</p>
Alarm only	<p>The controller only acts as leak detection alarm for a single indoor unit.</p> <p>No functionality described under "13 Operation" [▶ 50] is available.</p> <p>For information on the leak detection alarm, see "7.2 Refrigerant leak detection" [▶ 33].</p> <p>The controller can be a master or a slave controller.</p>
Supervisor	<p>The controller only acts as leak detection alarm for the whole system, i.e. multiple indoor units and their respective controllers. This mode is intended for a controller that is to be used in a supervision location, e.g. the reception desk of a hotel.</p> <p>No functionality described under "13 Operation" [▶ 50] is available.</p> <p>For information on the leak detection alarm, see "7.2 Refrigerant leak detection" [▶ 33].</p> <p>The controller can only be a slave controller.</p>

For more information on how to set the controller to be operable in a specific mode, see ["To configure the controller" \[▶ 46\]](#). When using "Supervisor" mode, it is important to set the supervised room address in order to know for which indoor unit the refrigerant leak alarm occurs. See ["Supervised room address" \[▶ 123\]](#) for more information.

12.1.1 To configure the controller

You can configure the controller to be operable in either one of three modes. For more information about the modes, see "[12.1 About the controller](#)" [▶ 45].

Mode	Configuration
Normal (default)	Change remote controller field setting: Mode: R2 SW: 5 Value: 0
Alarm only	Change remote controller field setting: Mode: R2 SW: 5 Value: 1
Supervisor	Change remote controller field setting: Mode: R2 SW: 5 Value: 2





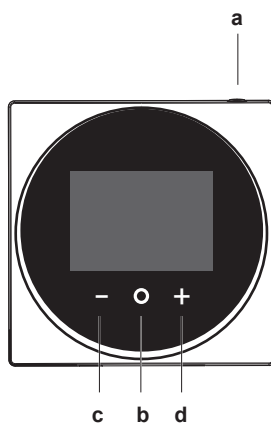













For more information on how to change remote controller field settings, see "[Field settings](#)" [▶ 69].

12.2 Buttons









- a** ON/OFF
 - When OFF, press to turn ON the system.
 - When ON, press to turn OFF the system.
- b** ENTER/ACTIVATE /SET
 - From the home screen, enter the main menu.
 - From the main menu, enter one of the submenus.
 - From their respective submenu, activate an operation/ventilation mode.
 - In one of the submenus, confirm a setting.
- c** CYCLE/ADJUST
 - Cycle left.
 - Adjust a setting (default: decrease).
- d** CYCLE/ADJUST
 - Cycle right.
 - Adjust a setting (default: increase).

12.3 Status icons

Icon	Description
	System operation ON. Indicates that the system is in operation.
	System operation OFF. Indicates that the system is NOT in operation.
	Bluetooth. ⁽¹⁾ Indicates that the controller is communicating with a mobile device, for use with the Madoka Assistant app.
	Lock. Indicates that a function or operation mode is locked and therefore cannot be used or selected.
	Centralised control. Indicates that the system is controlled by central control equipment (optional accessory) and that control of the system by the controller is limited.
	Changeover under centralised control. Indicates that the cooling/heating changeover is under centralised control by another indoor unit, or by an optional cool/ heat selector that is connected to the outdoor unit.
	Defrost/Hot start. Indicates that the defrost/hot start mode is active.
	Schedule/Timer. Indicates that the system operates according to a schedule, or that the OFF timer is enabled.
	Time not set. Indicates that controller's time is not set.
	Self-cleaning filter operation. Indicates that self-cleaning filter operation is active.
	Quick Start. Indicates that Quick Start mode is active (Sky Air only).
	Test operation. Indicates that Test Operation mode is active (Sky Air only).
	Inspection. Indicates that the indoor or outdoor unit is being inspected.
	Periodic inspection. Indicates that the indoor or outdoor unit is being inspected.
	Backup. Indicates that in the system an indoor unit is set as backup indoor unit.
	Individual airflow direction. Indicates that the individual airflow direction setting is enabled.
	Information. Indicates that the system has a message to convey. To see the message, go to the information screen.
	Warning. Indicates that an error occurred, or that an indoor unit component needs to be maintained.

⁽¹⁾ The Bluetooth® word mark and logos are registered trademarks owned by the Bluetooth SIG, Inc. and use of such marks by Daikin Europe N.V. is under license. Other trademarks and trade names are those of their respective owners.

Icon	Description
	Power consumption limit. Indicates that the system's power consumption is being limited, and that it is running with restricted capacity.
	End of power consumption limit. Indicates that the system's power consumption is no longer being limited, and that it is no longer running with restricted capacity.
	Rotation. Indicates that Rotation mode is active.
	Setback. Indicates that the indoor unit is operating under setback conditions.
	Ventilation. Indicates that a heat reclaim ventilation unit is connected.

 **INFORMATION**

- For information on the operation mode and ventilation mode icons, see "[13.2 Operation mode](#)" [▶ 54] and "[Ventilation mode](#)" [▶ 65] respectively.
- Most icons are related to things set in the Madoka Assistant app. For more information, see the app.

12.4 Status indicator

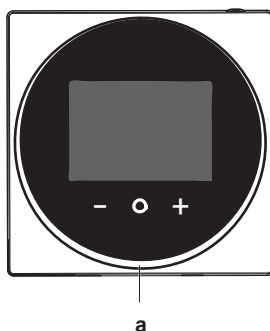

a Status indicator

12.4.1 Behaviour

The behaviour of the status indicator depends on remote controller field setting R1-11 (status indicator mode). Depending on the value that is set for this setting, the status indicator has the following behaviour:

Operation state	Status indicator behaviour		
	0 (Normal)	1 (Hotel setting 1)	2 (Hotel setting 2)
Operation ON	ON	ON	ON (when the backlight goes into faint state, the status indicator turns OFF)
Operation OFF	OFF	OFF	OFF
Error	Blinking	(no change)	(no change)

Operation state	Status indicator behaviour		
	0 (Normal)	1 (Hotel setting 1)	2 (Hotel setting 2)
Warning	ON	ON	ON (when the backlight goes into faint state, the status indicator turns OFF)
Setting of status indicator intensity	ON	ON	ON
Pairing with indoor unit	Blinking	Blinking	Blinking

**INFORMATION**

Remote controller field setting R1-11 allows for changes to the behaviour of the status indicator, making the controller suitable for use in hotels.

**INFORMATION**

By default, the controller is in status indicator mode "Hotel 2".

13 Operation

In this chapter

13.1	Basic usage.....	50
13.1.1	Screen backlight.....	50
13.1.2	Home screen.....	51
13.1.3	Information screen.....	52
13.1.4	Main menu.....	53
13.2	Operation mode.....	54
13.2.1	About the operation modes.....	54
13.2.2	To set the operation mode.....	58
13.3	Setpoint.....	58
13.3.1	About the setpoint.....	59
13.3.2	To set the setpoint.....	61
13.4	Date and time.....	61
13.4.1	About date and time.....	61
13.4.2	To set date and time.....	62
13.5	Airflow.....	62
13.5.1	Airflow direction.....	62
13.5.2	Fan speed.....	63
13.6	Ventilation.....	65
13.6.1	Ventilation mode.....	65
13.6.2	Ventilation rate.....	66
13.7	Advanced usage.....	66

13.1 Basic usage

13.1.1 Screen backlight

For the controller to be operable, the screen backlight needs to be ON. Otherwise, the controller does not detect any button presses.

After a period of operation inactivity, the backlight will either turn OFF, or go into a faint ON state, depending on operation conditions:

- Operation OFF: backlight OFF;
- Operation ON: backlight ON faintly.



INFORMATION

- Backlight state changeover after inactivity is set with remote controller field setting R1-8 (No-operation timer). For more information, see "[Remote controller field settings](#)" [▶ 75].
- Backlight faintness is set with remote controller field setting R1-10 (Backlight faintness). For more information, see "[Remote controller field settings](#)" [▶ 75].
- For instructions on how to set screen brightness and contrast when the backlight is ON, see "[Screen settings](#)" [▶ 68].

To turn ON the backlight

- 1 Press shortly.

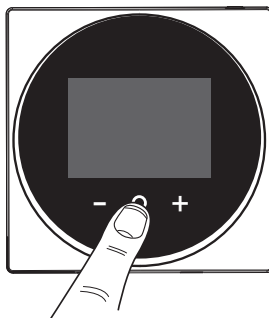

13.1.2 Home screen

Home screen mode

Depending on configuration, the controller either has a standard or a detailed home screen. While the standard home screen gives you only limited information, the detailed home screen gives you all kinds of information through status icons. After a period of operation inactivity, the controller will always revert to the home screen.

Standard	Detailed

Home screen operation

In certain conditions, the controller allows you to perform actions from the home screen.

Condition	Action
The system is running in Cooling, Heating, or Auto operation mode.	Change the setpoint
The system is composed of ONLY heat reclaim ventilation units.	Change the ventilation rate



INFORMATION

- Depending on configuration, the home screen displays the setpoint either as a numerical value, or as a symbol. For more information, see "[About the setpoint](#)" [▶ 59].
- In case the home screen displays the setpoint as a symbol, then it will only display the status icons of the standard home screen mode, even when the controller is in detailed home screen mode.





INFORMATION

The controller is equipped with a power saving function that causes the screen to go blank after a period of inactivity. To make the screen light up again, press one of the buttons.

13.1.3 Information screen

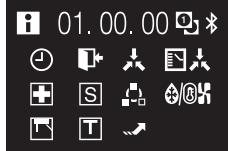
The controller collects operation information in an information screen.



When there is information to convey, the controller displays  in the top left corner of the home screen.



a 

On the information screen, you can find the following information:

Status icons



For the meaning of the status icons, see "[12.3 Status icons](#)" [▶ 47].

Software version



a Software version



INFORMATION

- The presence of icons on the information screen depends on operation status. The controller may display more or less icons than are indicated here.
- The information screen always displays the current software version, regardless of operation status.

To enter the information screen

Prerequisite: The controller displays the home screen.

- 1 Press  and keep it pressed until the information screen appears.

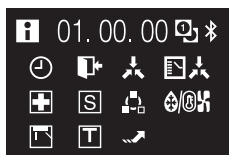

13.1.4 Main menu

From the home screen, press to enter the main menu. Use and to cycle through the menus. Press again to enter one of the menus.

Menu	Description
	Operation mode. Set the operation mode.
	Date and time. Make date and time settings.
	Airflow direction. Set the indoor unit airflow direction.
	Fan speed. Set the indoor unit fan speed.
	Ventilation mode. Set the ventilation operation mode.
	Ventilation rate. Set the fan speed for ventilation operation.
	Bluetooth. Activate Bluetooth to control the system with the Madoka Assistant app, and/or to perform a remote controller software update.



INFORMATION

- Depending on the type of indoor unit you are operating, more or less menus may be available.
- In the main menu, the icon for each menu reflects the current active setting or mode. When operating the controller, the menu you navigate through can look different from that represented in this manual.
- The controller only allows for basic operation of the system. For advanced operation (setback, schedule timer, ...), see the Madoka Assistant app.









INFORMATION

It is possible that menus are locked. When this is the case, they appear crossed-out in the main menu, and get accompanied by a lock icon. The locking of functions happens through the Madoka Assistant app. For more information, see the Madoka Assistant app and "[Function lock](#)" [▶ 114](#)].



13.2 Operation mode

The indoor unit can operate in various operation modes.

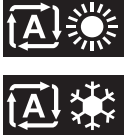
Icon	Operation mode
	Cooling. In this mode, cooling will be activated as required by the setpoint, or by Setback operation.
	Heating. In this mode, heating will be activated as required by the setpoint, or by Setback operation.
	Fan Only. In this mode, air circulates without heating or cooling.
	Dry. In this mode, the air humidity will be lowered with a minimal temperature decrease. The temperature and fan speed are controlled automatically and cannot be controlled by the controller. Dry operation will not function if the room temperature is too low.
	Ventilation. In this mode, the space gets ventilated, but not cooled or heated.
	Air Clean. In this mode, the optional air cleaning unit operates.
	Ventilation + Air Clean. Combination of ventilation and air clean operation.
	Auto. In Auto mode, the indoor unit automatically switches between heating and cooling mode, as required by the setpoint.



INFORMATION

Depending on the indoor unit, more or less operation modes are available.

13.2.1 About the operation modes



INFORMATION

If the indoor unit is a cooling-only model, it can only be set to run in Cooling, Fan only, or Dry operation mode.



INFORMATION

When operation modes are not available in the operation mode menu, it is additionally possible that they are locked. The locking of operation modes occurs through the Madoka Assistant app. For more information, see the Madoka Assistant app and "[Function lock](#)" [▶ 114].



INFORMATION

If the operation mode changeover of an indoor unit is under centralised control ('changeover under centralised control' status icon blinking in the home screen), then it is NOT possible to change the operation mode of that indoor unit. For more information, see "[Cooling/Heating masterhood](#)" [▶ 86].

Cooling

If the outdoor air temperature is high, it can take some time until the indoor room temperature reaches the setpoint temperature.

When the indoor room temperature is low, and the indoor unit is set to run in Cooling operation mode, the indoor unit can enter Defrost operation mode first (i.e. Heating operation), this to prevent a decrease of the system's cooling capacity due to frost on the heat exchanger. For more information, see "Heating" [▶ 55].



The indoor unit can run in Cooling operation mode because it is operating under Setback conditions. For more information, see "Setback" [▶ 110].

Heating

When running in Heating operation mode, the system requires a longer time to reach the setpoint temperature than when running in Cooling operation mode. To make up for this, it is recommended to let the system start operation in advance by making use of the timer function.

The indoor unit can run in Heating operation mode because it is operating under Setback conditions. For more information, see "Setback" [▶ 110].

To prevent cold drafts and a reduction of the system's heating capacity, the system can run in the following special heating operation modes:

Operation	Description
Defrost	<p>To prevent the loss of heating capacity due to frost accumulation in the outdoor unit, the system will automatically switch to defrost operation.</p> <p>During defrost operation, the indoor unit fan will stop operation, and the following icon will appear on the home screen:</p>  <p>The system will resume normal operation after approximately 6 to 8 minutes.</p>
Hot start (VRV only)	<p>During hot start, the indoor unit fan will stop operation, and the following icon will appear on the home screen:</p> 



INFORMATION

When the system is stopped while the indoor unit is running in Heating operation mode, the fan will continue to operate for approximately 1 minute, this to get out any heat remaining in the indoor unit.



INFORMATION

- The lower the outdoor air temperature, the lower the heating capacity. If the system's heating capacity is insufficient, it is recommended to include another heating appliance into the setup (if you use a combustion appliance, ventilate the room regularly. Also, do not use the heating appliance in places where it is exposed to the airflow of the indoor unit).
- The indoor unit is of the hot air circulation type. As a result, after operation start, it takes the indoor unit some time to warm up the room.
- The indoor unit fan will automatically operate until the indoor temperature of the system rises to a certain level.
- When hot air stays under the ceiling and your feet feel cold, it is recommended to include a circulator into the setup.

Dry



NOTICE

To prevent water leakage or system failure, do NOT turn off the system immediately after indoor unit operation. Before turning off the system, wait until the drain pump finishes discharging any water remaining in the indoor unit (approximately 1 minute).



INFORMATION

To ensure a smooth start, do not turn off the system while it is operating.

Auto



INFORMATION

In case of indoor unit setpoint logic, the system cannot run in Auto operation mode. Therefore, to allow for Auto operation mode, go for remote controller setpoint logic. For more information, see the Madoka Assistant app and "Setpoint logic" [▶ 109].

The Auto operation mode logic depends on the set setpoint logic (Madoka Assistant app setting).

Single setpoint	Dual setpoint
C2 ----- } 0.5°C - 2°C + C1 ----- } 0.5°C - 2°C SP ----- C2 ----- } 0.5°C - 2°C + C1 ----- } 0.5°C - 2°C	C2 ----- } 0.5°C - 2°C + C1 ----- } 0.5°C - 2°C SP ----- } DIFF SP ----- } 0.5°C - 2°C + C1 ----- } 0.5°C - 2°C C2 ----- } 0.5°C - 2°C

	Cooling setpoint
	Heating setpoint
DIFF	Minimum setpoint differential between the Heating and the Cooling setpoint
+C1	Changeover setpoint (with guard timer)
C2	Forced changeover setpoint
0.5°C~2°C	Field settable temperature intervals between setpoints

**INFORMATION**

The default value of the settable temperature range (0.5°C~2°C) is 0.5°C.

A changeover from the one operation mode to the other occurs in the following cases:

Case 1: primary changeover (☀+C1)

A changeover occurs from the moment the room temperature rises above/drops below the Cooling/Heating changeover setpoint (C1), and the guard timer has run out.

Example:

Single setpoint	Dual setpoint
<p>The system is heating up the room. When after a while the room temperature rises above C1 (23°C), a changeover from Heating to Cooling occurs, provided that the guard timer has run out. If the guard timer has not run out, the changeover will only occur from the moment the timer does run out. As a result of the changeover, the guard timer starts running again so as to allow for or prevent the next changeover.</p> <p>The system is cooling down the room. When after a while the room temperature drops below C1 (21°C), a changeover from Cooling to Heating occurs, provided that the guard timer has run out. If the guard timer has not run out, the changeover will only occur from the moment the timer does run out. As a result of the changeover, the guard timer starts running again, to allow for or prevent the next changeover.</p>	<p>The system is heating up the room. When after a while the room temperature rises above C1 (25°C), a changeover from Heating to Cooling occurs, provided that the guard timer has run out. If the guard timer has not run out, the changeover will only occur from the moment the timer does run out. As a result of the changeover, the guard timer starts running again so as to allow for or prevent the next changeover.</p> <p>The system is cooling down the room. When after a while the room temperature drops below C1 (21°C), a changeover from Cooling to Heating occurs, provided that the guard timer has run out. If the guard timer has not run out, the changeover will only occur from the moment the timer does run out. As a result of the changeover, the guard timer starts running again, to allow for or prevent the next changeover.</p>

Case 2: forced changeover (C2)

A changeover is forced from the moment the room temperature rises above/drops below the Cooling/Heating forced changeover setpoint (C2) while the guard timer is still running.

Example:

Single setpoint	Dual setpoint
<p>The system is heating up the room. When the room temperature rises above C2 (24°C) while the guard timer is still running, a changeover is forced from Heating to Cooling.</p> <p>The system is cooling down the room. When the room temperature drops below C2 (20°C) while the guard timer is still running, a changeover is forced from Cooling to Heating.</p>	<p>The system is heating up the room. When the room temperature rises above C2 (26°C) while the guard timer is still running, a changeover is forced from Heating to Cooling.</p> <p>The system is cooling down the room. When the room temperature drops below C2 (20°C) while the guard timer is still running, a changeover is forced from Cooling to Heating.</p>

i INFORMATION

To prevent operation mode changeovers from occurring too frequently, changeovers typically occur only after the guard timer has run out (i.e. Case 1). However, to prevent the room from getting too hot or too cold, a changeover is forced when the room temperature reaches C2 while the guard timer is still running (i.e. Case 2).

13.2.2 To set the operation mode

- 1 Navigate to the operation mode menu.



- 2 Use **-** and **+** to select an operation mode.

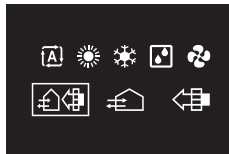

- 3 Press **OK** to activate.

Result: The indoor unit changes its operation mode and the controller returns to the home screen.

13.3 Setpoint

The setpoint is the target temperature for the Cooling, Heating, and Auto operation modes.

**INFORMATION**

The lower setpoint limit of the Cooling operation mode is 20°C, as per UAE Federal regulation UAE.S 5010-5:2016 clause 6, and UAE.S 5010-1:2016 clause 10.

13.3.1 About the setpoint

Depending on configuration, the home screen displays the temperature setpoint either as a numerical value, or as a symbol.

**INFORMATION**

For how to set the home screen setpoint, see the Madoka Assistant app. Also see ["Screen" \[▶ 104\]](#).

Home screen setpoint: Numerical

In case the home screen displays the temperature setpoint as a numerical value, you control the room temperature by raising or lowering the setpoint by 1°C increments.



The default setpoint range is 16°C~32°C. If any limitations are set to this range with the setpoint range function (Madoka Assistant app function; see ["Setpoint range" \[▶ 112\]](#)), it is only possible to raise or lower the setpoint up/down to the set maximum/minimum setpoint range limits.

Home screen setpoint: Symbolic

In case the home screen displays the temperature setpoint as a symbol, you control the room temperature by raising or lowering the setpoint in relation to the "reference setpoint" (visually indicated by the marker in the middle of the thermometer).



It is possible to raise the setpoint up to three steps of 1°C above and up to three steps of 1°C below the reference setpoint.

Example: if the reference setpoint is 25°C, it is possible to raise the setpoint to 28°C and lower it to 22°C.

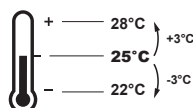
**INFORMATION**

For how to set the reference setpoint, see the Madoka Assistant app. Also see ["Screen" \[▶ 104\]](#).

Exceptions to this logic are possible in case of:

- Setpoint range limitations
- Central control / control by a schedule

Setpoint range

If any limitations are set to the default setpoint range (16°C~32°C) with the setpoint range function (Madoka Assistant app function; see "Setpoint range" [▶ 112]), it is only possible to raise or lower the setpoint up/down to the set upper/lower setpoint range limits.

Example: if the reference temperature is 25°C, you can normally lower the setpoint three steps to 22°C. However, if a setpoint range limit is set to 23°C, you can only lower the setpoint to 23°C.

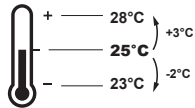

Central control / Schedule

If the system is under the control of a centralised controller or a schedule, then the regular +3°C/-3°C setpoint range limits can get overruled AND changed.

IF	THEN
The centralised controller or schedule imposes a setpoint that is within the regular +3°C/-3°C setpoint range.	Nothing unusual happens and the system follows the regular setpoint and setpoint range logic.

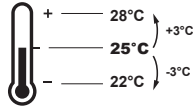
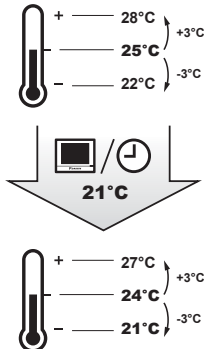
IF	THEN
<p>The centralised controller or schedule imposes a setpoint that exceeds the regular +3°C/−3°C setpoint range.</p>	<p>The imposed setpoint becomes the new upper/lower limit of the +3°C/−3°C range, and the whole range shifts in relation to this new limit.</p> <p>Example: the reference setpoint is set to 25°C, yielding the following setpoint range:</p>  <p>If the centralised controller or schedule changes the setpoint to 21°C, which is below the range, then "21°C" becomes the new lower limit, and the range shifts in relation to this new limit.</p> 

13.3.2 To set the setpoint

Prerequisite: The active operation mode is either 'Cooling', 'Heating', or 'Auto'.

- 1 In the home screen, use  and  to adjust the setpoint.





Result: The indoor unit changes its temperature setpoint.

13.4 Date and time

Set the date and time for the indoor units connected to the controller.

13.4.1 About date and time

Depending on daylight saving time settings, the date and time menu has the following daylight saving time indicators:

	Summer time
	Winter time

For more information, see "[Indoor unit field settings](#)" [[▶ 73](#)] (remote controller settings) and "[Date and time](#)" [[▶ 105](#)] (app settings).

13.4.2 To set date and time

- 1 Navigate to the date and time menu.

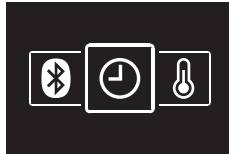

- 2 Press **+** to activate .

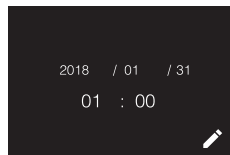

Result: The fields become editable.

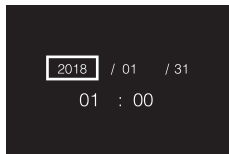

- 3 Set the date and time. Set with **-** and **+**. Confirm with **○**. Cycle through the menu until all fields are set correctly.

Result: You set the date and the time.



INFORMATION

Confirming the value in a field will automatically bring you to the next field. To finish making settings and leave the menu, navigate to and confirm the value in the last field.



13.5 Airflow

13.5.1 Airflow direction

The airflow direction is the direction in which the indoor unit blows its air.

About airflow direction

The following airflow directions can be set:

Direction	Screen
Fixed position. The indoor unit blows air in 1 of 5 fixed positions.	
Swing. The indoor unit alternates between the 5 positions.	
Auto. The indoor unit adjusts its airflow direction according to movement sensed by a movement sensor.	



INFORMATION

- Depending on the type of indoor unit, and/or on system layout and organisation, Auto airflow direction may not be available.
- For some types of indoor unit, you cannot set the airflow direction.

Automatic airflow control



In the following operating conditions, the airflow direction of the indoor units is controlled automatically:

- When the room temperature is higher than the controller's setpoint for Heating operation (including Auto operation).
- When the indoor units run in Heating operation mode, and the Defrost function is active.
- When the indoor units run in Continuous operation, and the airflow direction is Horizontal.

To set the airflow direction

- 1 Navigate to the airflow direction menu.



- 2 Use  and  to adjust the airflow direction.



- 3 Press  to confirm.



Result: The indoor unit changes its airflow direction and the controller returns to the home screen.

13.5.2 Fan speed

The fan speed is the strength of the airflow coming out of the indoor unit.

About fan speed

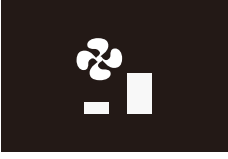
Depending on the indoor unit, you can choose between either:

Fan speed	Screen
2 fan speeds	
3 fan speeds	
5 fan speeds	

Some indoor units additionally support Automatic fan speed. In this case, the indoor unit adjusts its fan speed automatically, according to the setpoint and indoor temperature.

Fan speed	Screen
Automatic	





INFORMATION

- For mechanical protection purposes, it is possible that the indoor unit switches itself to 'Automatic fan speed' mode.
- If the fan stops operating, this does not necessarily mean system failure. The fan can stop operating at all times.
- It may take some time before changes made to fan speed settings are actually carried out.

To set the fan speed

- Navigate to the fan speed menu.



- Use  and  to adjust the fan speed.



- Press  to confirm.

Result: The indoor unit changes its fan speed and the controller returns to the home screen.

13.6 Ventilation



INFORMATION

Ventilation settings can ONLY be made for heat reclaim ventilation units.

13.6.1 Ventilation mode

The heat reclaim ventilation unit can operate in various operation modes.

Icon	Ventilation mode
	Energy Reclaim Ventilation. The outdoor air is supplied to the room after passing through a heat exchanger.
	Bypass. The outdoor air is supplied to the room without passing through a heat exchanger.
	Auto. To ventilate the room in the most efficient way, the heat reclaim ventilation unit automatically switches between "Bypass" and "Energy Reclaim Ventilation" mode (based on internal calculations).



INFORMATION

Depending on the heat reclaim ventilation unit, more or less ventilation modes are available.



INFORMATION

Ventilation mode changes are possible regardless of Cooling/Heating masterhood. For more information, see "[Cooling/Heating masterhood](#)" [▶ 86].



NOTICE

Before starting up the system, the unit MUST be energised for at least 6 hours to avoid compressor breakdown during startup.



INFORMATION

To ensure a smooth start, do not turn off the system while it is operating.

To set the ventilation mode

- 1 Navigate to the ventilation mode menu.



- 2 Use and to select a ventilation mode.



- 3 Press to activate.

Result: The heat reclaim ventilation unit changes its operation mode and the controller returns to the home screen.

13.6.2 Ventilation rate

The ventilation rate is the fan speed during ventilation operation.

To set the ventilation rate

- 1 Navigate to the ventilation rate menu.

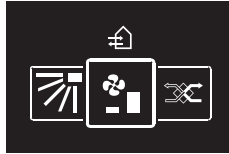

- 2 Use  and  to adjust the ventilation rate.

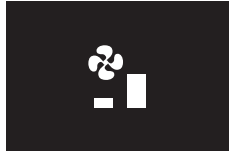

- 3 Press  to confirm.

Result: The heat reclaim ventilation unit changes its ventilation rate and the controller returns to the home screen.

13.7 Advanced usage

The controller only allows for basic operation. For advanced operation, use the Madoka Assistant app.

**INFORMATION**

To operate the controller with the app, you need to connect the controller to a mobile device on which the app is installed. For instructions, see "[15.2 Pairing](#)" [▶93].

14 Configuration











In this chapter

14.1	Installer menu	67
14.1.1	About the installer menu	67
14.1.2	Screen settings	68
14.1.3	Status indicator settings.....	69
14.1.4	Field settings.....	69
14.1.5	Miscellaneous settings.....	76
14.2	Software update	89
14.2.1	About software updates	89
14.2.2	Software update with app	89
14.2.3	Software update with updating tool.....	90

14.1 Installer menu

14.1.1 About the installer menu

In the installer menu you can make the following settings:

Category	Icon	Settings
Screen settings		Brightness
		Contrast
Status indicator settings		Intensity
Field settings		Indoor unit field settings
		Remote controller field settings
Miscellaneous settings		Group address and AirNet address
		External input interlock
		Force fan ON
		Cooling/Heating masterhood
		Refrigerant leak alarm test
		Information

To enter the installer menu

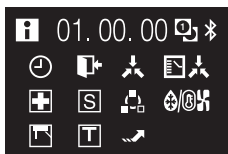

Prerequisite: The controller displays the home screen.

- 1 Press  and keep it pressed until the information screen appears:



INFORMATION

- The presence of icons on the information screen depends on operation status. The controller may display more or less icons than are indicated here.
- The information screen always displays the current software version, regardless of operation status.

- 2 From the information screen, press  and  simultaneously and keep them pressed until you enter the installer menu:

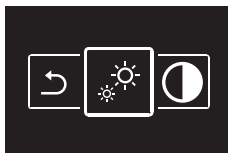

Result: You are now in the installer menu.

14.1.2 Screen settings

To set screen brightness

Prerequisite: You are in the installer menu.

- 1 Navigate to the screen brightness menu.

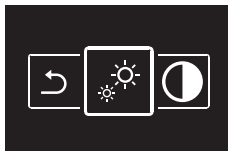

- 2 Use  and  to adjust screen brightness.



- 3 Press  to confirm.



Result: The screen adjusts its brightness and the controller returns to the installer menu.

To set screen contrast

Prerequisite: You are in the installer menu.

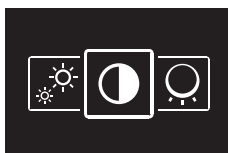
- 1 Navigate to the screen contrast menu.



- 2 Use  and  to adjust screen contrast.



- 3 Press  to confirm.

Result: The screen adjusts its contrast and the controller returns to the installer menu.

14.1.3 Status indicator settings

To set status indicator intensity

Prerequisite: You are in the installer menu.

- 1 Navigate to the status indicator intensity menu.



- 2 Use  and  to adjust status indicator intensity.



- 3 Press  to confirm.

Result: The status indicator adjusts its intensity and the controller returns to the installer menu.

14.1.4 Field settings

About field settings

The controller allows for making field settings related to the indoor unit, and to the controller itself.

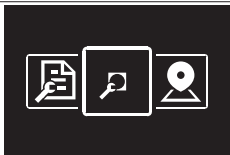
Screen	Field settings
	Indoor unit
	Remote controller

In both case, the setting procedure is the same. For instructions, see "[Setting procedure](#)" [[▶ 70](#)].





Setting procedure

Field settings are composed of the following components:

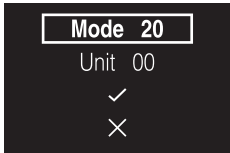
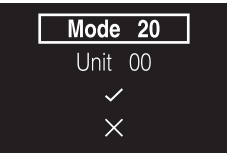
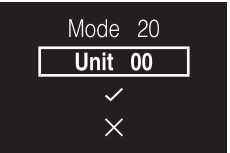
- 1 Modes ("Mode"),
- 2 Units ("Unit"),
- 3 Settings ("SW"), and
- 4 Values for those settings.

The field settings menus have two levels. You set modes and units in the first level, and settings and values in the second.

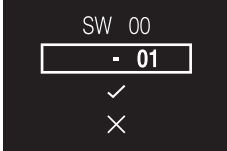
Level	Description
<p>First level</p> 	<p>Mode (Mode)</p>  <p>A mode is a group of settable parameters.</p> <p>In the field settings tables, find available mode numbers in the "Mode" column. Mode numbers that apply to individual indoor units are between brackets in the "Mode" column.</p> <hr/> <p>Unit (Unit) (indoor unit field settings only)</p>  <p>A unit is an individual unit to which a setting might apply.</p> <p>When making field settings for individual units, this is the place where you define the number of the unit to which the setting applies.</p> <p>When making field settings for grouped units, you do NOT set the unit number. The settings will then apply to all indoor units that are part of that group.</p>

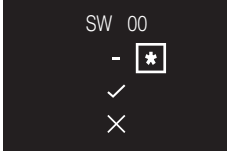
Level	Description
Second level 	<p data-bbox="675 208 823 237">Setting (SW)</p>  <p data-bbox="675 423 1433 488">A setting is a settable parameter. These are the settings you are making.</p> <p data-bbox="675 504 1474 568">In the field settings tables, find the available setting numbers in the "SW" column.</p> <hr/> <p data-bbox="675 589 746 618">Value</p>  <p data-bbox="675 801 1417 866">A value is one of a fixed set of values that you can choose for a setting.</p> <p data-bbox="675 882 1482 947">When the value field contains a "-", there are no values available for the selected setting:</p>  <p data-bbox="675 1131 1482 1234">When making group settings, you can ONLY set a value for a setting if the value field contains a "*" (if the value field does NOT contain a "*", you cannot apply the selected setting to the group):</p>  <p data-bbox="675 1417 1474 1482">In the field settings tables, find the available values for each setting in the "Value" column.</p>

Navigation

To navigate through the field settings menus, use **←**, **○**, and **+**.

- 1 Use **←** and **+** to move the highlighter.

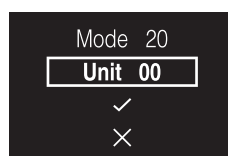

- 2 Press **○** to select a field setting component.

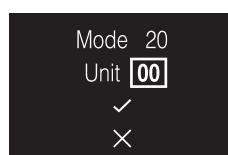

- 3 Use **←** and **+** to change the value of that field setting component.

- 4 Press to confirm that value.
- 5 In the first level, select to move to the second level.

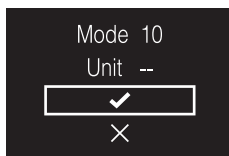

- 6 In the second level, navigate and select in the same way as you did in the first level.
- 7 Select to confirm and activate made settings.

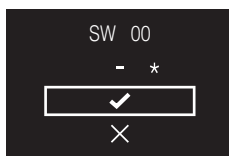

- 8 At all times, select to go back a level.

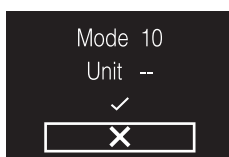

Indoor unit field settings

The setting procedure is different depending on whether you want to make settings for individual indoor units, or for groups of indoor units.

Individual indoor units

- Define a mode by setting a Mode number (number between brackets)
- Define the unit to which the setting will apply by setting a Unit number
- Define the setting by setting a SW number
- Define a value for that setting

Groups of indoor units

- Define a mode by setting a Mode number (number NOT between brackets)
- Do NOT set a Unit number (setting applies to all the units in the group)
- Define the setting by setting a SW number
- Define a value for that setting

Mode	SW	Setting (SW) description	—						
			01	02	03	04			
10 (20)	00	Filter contamination timer: set the timer for the appearance of the "Time to clean filter" screen.	Ultra long life filter	Light	±10000 hrs.	Heavy	±5000 hrs	—	—
			Long life filter		±2500 hrs		±1250 hrs		
			Standard filter		±200 hrs		±100 hrs		
	01	Long life filter: if applicable, set which type of long life filter is used.	Long life filter		Ultra long life filter		—	—	
02	Controller thermostat sensor: set how the controller thermostat sensor is used.	Used in combination with indoor unit thermistor		Not used		Used exclusively	—		
03	Disable filter sign: set whether or not the filter sign can be displayed.	Display		Do not display		—	—		
11 (21)	00	Simultaneous operation: set the simultaneous indoor unit operation mode (Sky Air)	Pair		Twin		Triple	Double twin	
12 (22)	01	External On/OFF input: set the operation of voltage free contacts T1/T2 (indoor unit contacts)	Forced OFF		On/OFF operation		Emergency	Forced OFF (multi-tenant)	
	02	Thermostat differential: if the system contains a remote sensor, set the increase/decrease increments.	1°C		0.5°C		—	—	
13 (23)	00	High air outlet velocity: set in case of high-ceiling applications.	hs<2.7 m		2.7 m<hs<3 m		3 m<hs<3.5 m		
	01	Airflow direction: set in case an indoor unit is equipped with an option kit that blocks the airflow.	4-way flow		3-way flow		2-way flow	—	
	03	Airflow function: set whether the indoor unit is equipped with a decoration panel at its air outlet.	Equipped		Not equipped				
	04	Airflow direction range	Upper		Normal		Lower	—	
	06	External static pressure: set the external static pressure (according to the resistance of the connected ducts). FHYK: follow the high-ceiling setting.	Normal		High static pressure		Low static pressure	—	
15 (25)	03	Humidification drain pump	Not equipped		Heating operation: continuous		Heating operation: 3 minutes ON/5 minutes OFF ^(a)		
1c	01	Thermostat sensor: set which thermostat sensor you want to use.	Indoor unit thermistor		Controller thermistor		—	—	
1c	12	Window contact B1 (external input)	Do not use		Use				
1c	13	Key card contact B2 (external input)	Do not use		Use				
1e	02	Setback function: set Setback operation.	No Setback		Heating only		Cooling only	Heating and Cooling	
1e	07	Rotation overlap time. Set the Rotation overlap time.	30 minutes		15 minutes		10 minutes	5 minutes	
1B	08	Daylight saving time. Set how the system controls daylight saving time.	Disable		Automatic changeover		Manual changeover	Centralised control	

^(a) This is applicable for codes 02-06. Codes 05 and 06 are not shown in the table. See the service manual for more detailed information.

**INFORMATION**

- The connection of optional accessories to the indoor unit might cause changes to some field settings. For more information, see the installation manual of the optional accessory.
- For details about the specific field settings of each type of indoor unit, see the installation manual of the indoor units.
- Field settings that are not available for a connected indoor unit are not displayed.
- Field setting default values are different depending on the indoor unit model. For more information, see the service manual of the indoor units.

Remote controller field settings

Mode	SW	SW description	Value	Default value
R1	3	Controller thermistor adjustment (Cooling)	0: -3.0°C, 1: -2.5°C, 2: -2.0°C, 3: -1.5°C, 4: -1.0°C, 5: -0.5°C, 6: ±0°C, 7: +0.5°C, 8: +1.0°C, 9: +1.5°C, 10: +2.0°C, 11: +2.5°C, 12: +3.0°C	6
	4	Controller thermistor adjustment (Heating)	0: -3.0°C, 1: -2.5°C, 2: -2.0°C, 3: -1.5°C, 4: -1.0°C, 5: -0.5°C, 6: ±0°C, 7: +0.5°C, 8: +1.0°C, 9: +1.5°C, 10: +2.0°C, 11: +2.5°C, 12: +3.0°C	6
	5	Controller thermistor adjustment (Auto)	0: -3.0°C, 1: -2.5°C, 2: -2.0°C, 3: -1.5°C, 4: -1.0°C, 5: -0.5°C, 6: ±0°C, 7: +0.5°C, 8: +1.0°C, 9: +1.5°C, 10: +2.0°C, 11: +2.5°C, 12: +3.0°C	6
	6	Controller thermistor adjustment (Fan only)	0: -3.0°C, 1: -2.5°C, 2: -2.0°C, 3: -1.5°C, 4: -1.0°C, 5: -0.5°C, 6: ±0°C, 7: +0.5°C, 8: +1.0°C, 9: +1.5°C, 10: +2.0°C, 11: +2.5°C, 12: +3.0°C	6
	7	Home screen	0: Detailed 1: Standard	1
	8	Backlight no-operation timer	0: 5 seconds 1: 10 seconds 2: 20 seconds	0
	9	Status indicator faintness	0: 0% (OFF), 1: 1%, 2: 2%, 3: 3%, 4: 5%, 5: 7%, 6: 9%, 7: 11%, 8: 13%, 9: 15%, 10: 17%, 11: 20%	9
	10	Backlight faintness	0: 0% (OFF), 1: 1%, 2: 2%, 3: 3%, 4: 4%, 5: 5%	5
	11	Status indicator mode	0: Normal 1: Hotel setting 1 2: Hotel setting 2	2
	13	Bluetooth Low Energy advertising	0: Always advertising 1: Enable manually	0

Mode	SW	SW description	Value	Default value
R2	1	Touch button indicator (on screen)	0: None 1: Small 2: Medium 3: Large	1
	5	Remote controller mode	0: Normal 1: Alarm only 2: Supervisor	0
1E	8	Home screen setpoint	1: Numerical 2: Symbolic	1



INFORMATION
 Remote controller field setting R1-11 allows for changes to the behaviour of the status indicator, making the controller suitable for use in hotels.

14.1.5 Miscellaneous settings

Group address

About group address

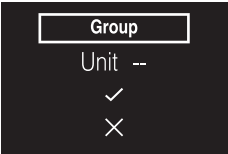
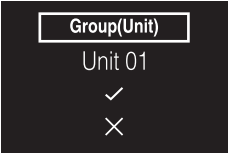
To control the system with central control equipment, it is required that you assign the indoor units with the necessary addresses. It is possible to assign an address to a group of indoor units, or to individual indoor units.

Group of indoor units	
Individual indoor units	

To assign an address to a group of indoor units

Prerequisite: You are in the installer menu.

- 1 Navigate to the address settings menu.

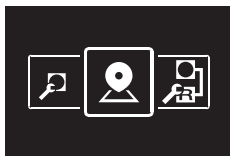

- 2 Select "Group"

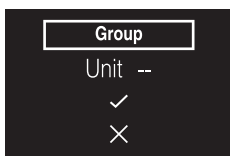

- 3 Confirm your selection.

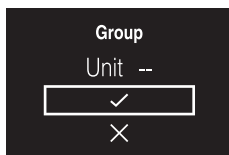

- 4 Define the address.

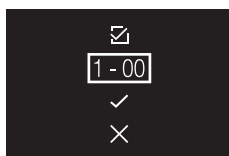

- 5 Before you confirm the address, make sure is selected.

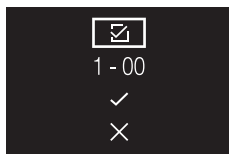

- 6 Confirm the address.

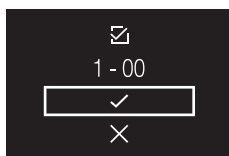

Result: You assigned an address to the group of indoor units.

To assign an address to an individual indoor unit

Prerequisite: You are in the installer menu.

- 1 Navigate to the address settings menu.

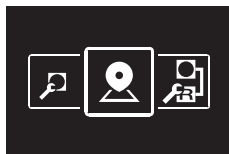

- 2 Select "Group(Unit)"

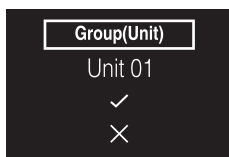

- 3 Define the indoor unit to which you want to assign the address.

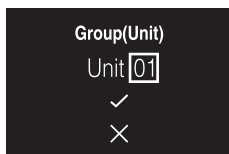

- 4 Confirm your selection.

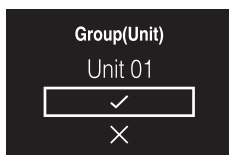

- 5 Define the address.

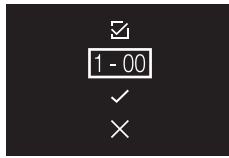

6 Before you confirm the address, make sure is selected.

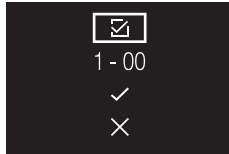

7 Confirm the address.

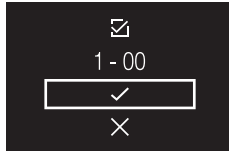

Result: You assigned an address to the indoor unit.

To remove an address

- 1 Navigate to the address that you want to remove.
- 2 Change to .

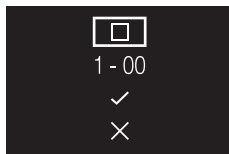

3 Confirm your selection.

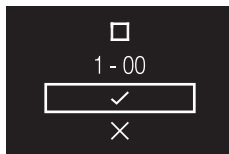

Result: The address gets removed.

AirNet address

About AirNet address

To connect the system to the AirNet monitoring and diagnostics system, it is required that you assign the indoor and outdoor units with the necessary addresses.

Indoor units	
Outdoor units	

To assign an AirNet address to an indoor unit

Prerequisite: You are in the installer menu.

- 1 Navigate to the address settings menu.

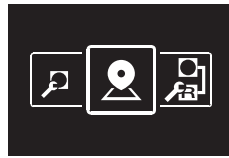

- 2 Select "I/U"

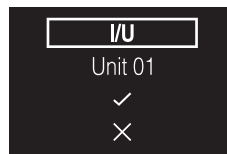

- 3 Define the indoor unit to which you want to assign the address.



- 4 Confirm your selection.

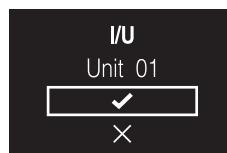

- 5 Define the address.

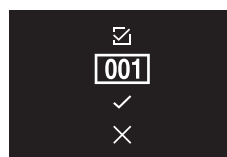

- 6 Before you confirm the address, make sure is selected.

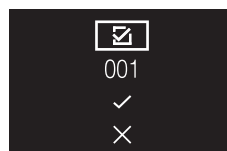

- 7 Confirm the address.

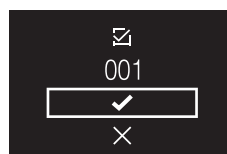

Result: You assigned an AirNet address to the indoor unit.

To assign an AirNet address to an outdoor unit

Prerequisite: You are in the installer menu.

- 1 Navigate to the address settings menu.

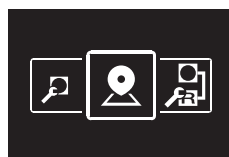

- 2 Select "O/U"

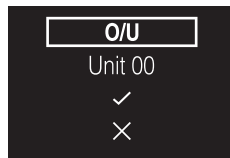

3 Define the outdoor unit to which you want to assign the address.

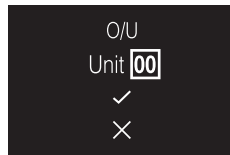

4 Confirm your selection.

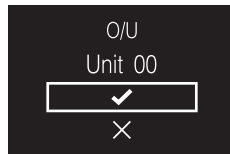

5 Define the address.

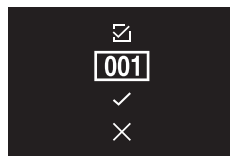

6 Before you confirm the address, make sure is selected.

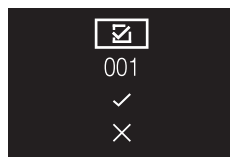

7 Confirm the address.

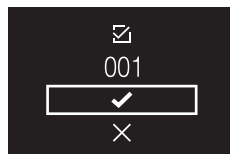

Result: You assigned an AirNet address to the outdoor unit.

To remove an address

1 Navigate to the address that you want to remove.

2 Change to .



3 Confirm your selection.

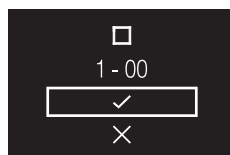

Result: The address gets removed.

External input interlock

About external input interlock

External input interlock allows for the integration of external contacts in the system's control logic. By adding a key card contact and/or a window contact to the control setup, it is possible to have the system respond to the insertion/removal of a key card in/from a card reader, and/or the opening/closing of windows.



INFORMATION

To use this function, it is required that digital input adapter BRP7A5* is part of the system.

- Make sure that the digital input adapter and its optional contacts (window contact B1 and key card contact B2) are correctly installed. Confirm that the voltage free contact of the digital input adapter is in the correct position. For instructions on how to install the digital input adapter, see the installation manual of the digital input adapter.
- When the digital input adapter does not function properly, external input interlock is not available in the menu.
- When the digital input adapter is part of the system, the system does not allow for the connection of a slave controller.
- When the digital input adapter is part of the system, it is not possible to use the Schedule function.
- When the digital input adapter is part of the system, as well as a centralised controller, the external input interlock function is controlled by the centralised controller, and not by the adapter.

To make external input interlock settings

Prerequisite: You are in the installer menu.

- 1 Navigate to the external input interlock menu.

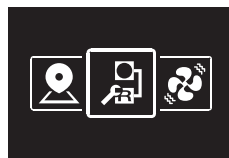

- 2 Use **←** and **→** to navigate through the menu.
- 3 Press **○** to select a parameter.
- 4 With a parameter selected, use **←** and **→** to change that parameter's value.
- 5 With a parameter selected, press **○** to confirm the value for that parameter.
- 6 When you are done making settings, confirm all settings by selecting **✓** and pressing **○**.

Result: The system will restart and implement any changes made.



INFORMATION

For an overview of settable parameters and what they mean, see "[External input interlock settings overview](#)" [▶ 82].

External input interlock settings overview

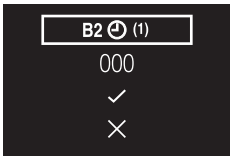
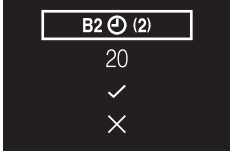
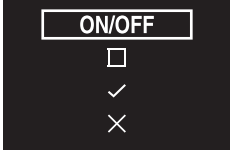
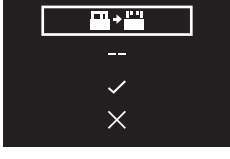
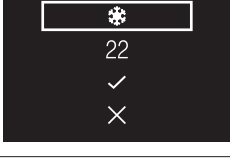
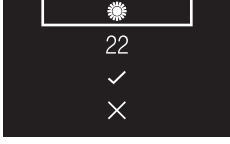
Parameter	Description	Possible values	Default value
B2 Delay Timer 	Timer that starts as soon as the key card is removed. The unit continues normal operation until the timer expires.	0-10 minutes	"1 min"
B2 Reset Timer 	Timer that starts as soon as the Delay Timer expires. When this timer expires, the previous state (i.e. regular setpoint) changes to the "Default Reset Setting" state.	0-20 hours	"20 hours"
Reset ON/OFF 	"Default Reset Setting" on/off state	"ON", "OFF", "--"	"OFF"
Reset Mode 	"Default Reset Setting" operation mode	Auto, Cooling, Heating, Fan only, --	"--"
Reset Cool SP 	"Default Reset Setting" cooling setpoint	See indoor unit's setpoint range and setpoint range limitation, "--"	"22°C"
Reset Heat SP 	"Default Reset Setting" heating setpoint	See indoor unit's setpoint range and setpoint range limitation, "--"	"22°C"



INFORMATION

When the value for a parameter is "--", this means that when the timers expires, nothing changes for that parameter and the current active value is kept.

Window contact logic

Window contact B1	Key card contact B2	Time	Action
Contact closed (window closed)	Contact closed (key card IN)	—	<ul style="list-style-type: none"> Normal indoor unit operation. The unit returns to the previous state before opening the contact.

Window contact B1	Key card contact B2	Time	Action
Contact open (window open)	Contact closed (key card IN)	—	Unit operation is forced off: <ul style="list-style-type: none"> ▪ No delay and reset timer functionality. ▪ No Setback functionality. ▪ Not possible to turn on/off the unit with the controller's ON/OFF button.

Key card contact logic

Window contact B1	Key card contact B2	Time	Action
Contact closed (window closed)	Contact closed (key card IN)	<ul style="list-style-type: none"> ▪ — ▪ Delay timer < Time < Reset timer ▪ Time > Reset timer 	<ul style="list-style-type: none"> ▪ The unit operates normally. ▪ If the reset timer has not expired, the unit returns to the previous state before opening the contact. ▪ If the reset timer has expired, the unit returns to the "Default Reset Setting" (see "External input interlock settings overview" [▶ 82]).
Contact closed (window closed)	Contact open (key card OUT)	Time < Delay timer	Normal indoor unit operation.
Contact closed (window closed)	Contact open (key card OUT)	Time > Delay timer	Unit operation is forced off: <ul style="list-style-type: none"> ▪ Depending on whether the Setback function is enabled, Setback will work or not. ▪ Not possible to turn on/off the unit with the controller's ON/OFF button. ▪ After the delay timer has expired, the reset timer will start counting.

**INFORMATION**

- The "previous state" can be the on/off state, operation mode, cooling setpoint, and heating setpoint.
- When using the contacts, the fan speed as well as the Setback cooling and heating setpoints can be changed at any time, without losing changes.
- The fan speed is stored independently for the two main operation modes (Heating and Cooling). Separate fan speed settings are saved for Heating operation mode on the one hand, and Cooling, Dry and Fan only operation mode on the other hand.
- When closing the contact, changes made while the key card contact is open and the delay timer has not expired (normal operation) will not be saved.

Combination of window contact and key card contact logic

- The window contact has priority over the delay timer and the Setback functionality of the key card contact:

When the window contact is opened while the key card contact is open, the delay timer will immediately expire if it is still running, and Setback will not work anymore. The reset timer will immediately start counting or will not reset when it was already running.

- The reset timer functionality of the key card contact has priority over the window contact when returning to the previous state:

When the key card contact is opened while the window contact is open, the delay timer will start running. When the delay timer expires the reset timer will start running. When the reset timer expires, the previous state is updated to the "**Default Reset Setting**" state.

Example 1

- 1 You remove the key card.

Result: The indoor unit continues operating normally until the delay timer expires.

- 2 You open the window before the delay timer expires.

Result: The indoor unit stops immediately. It is not possible to turn the unit on or off, the Setback functionality does not work, the delay timer stops counting, and the reset timer starts counting.

- 3 You insert the key card again.

Result: An update of the previous state occurs. The unit is forced off and the Setback functionality is still disabled (see "[Window contact logic](#)" [▶ 82]).

IF the reset timer HAS NOT expired before inserting the key card, the previous state is the same as the original state because there was only a change to the original state.

IF the reset timer HAS expired before inserting the key card, the previous state is the "**Default Reset Setting**" state.

- 4 You close the window.

Result: The unit reverts to the previous state. The previous state depends on the expiration of the reset timer.

Example 2

- 1 You open the window.
Result: The unit stops immediately. It is not possible to turn the unit on or off with the ON/OFF button, the Setback functionality does not work, and the delay timer does not start counting.
- 2 You remove the key card.
Result: The delay timer starts counting.
- 3 You close the window again.
Result: There is no change in state. It is as if you never opened the window (Setback will work if enabled).

IF the delay timer HAS expired before closing the window, the reset timer will have started counting. Closing the window has no influence on the reset timer.

IF the delay timer HAS NOT expired before closing the window, it will expire immediately and the reset timer will start counting. When the reset timer expires, the previous state is updated to the "Default Reset Setting" state.
- 4 You insert the key card again.
Result:

IF the reset timer HAS NOT expired before inserting the key card, the unit returns to the state before the window was opened (last "on" state);

IF the reset timer HAS expired before inserting the key card, the unit goes to the "Default Reset Setting" state.

Force fan ON

About Force fan ON

Force fan ON allows you to force fan operation of individual indoor units. In this way, you can check which indoor unit number was assigned to which indoor unit.

To force fan operation

Prerequisite: You are in the installer menu.

- 1 Navigate to the Force Fan ON menu.

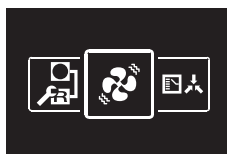

- 2 Select an indoor unit number.

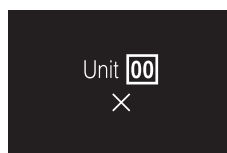

- 3 Select  and press  to force fan operation.



Result: The fan of the indoor unit that corresponds to the selected indoor unit number starts operating.

Cooling/Heating masterhood

About Cooling/Heating masterhood

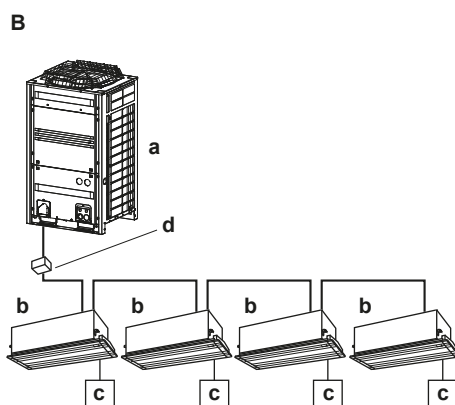
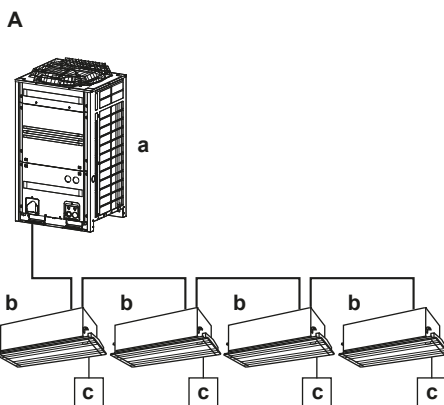

- A** Heat pump system
- B** Heat recovery system
- a** Outdoor unit
- b** Indoor unit
- c** Remote controller
- d** BS unit

When multiple indoor units are connected to an outdoor unit, one of these units (or a group of indoor units, in case of group control) needs to be set as Cooling/Heating master. The other units/groups then become Cooling/Heating slaves, and are restricted in their operation by the master (e.g. one outdoor unit does not allow for one indoor unit to run in Cooling operation while another runs in Heating operation).

When an indoor unit or group of indoor units is set as Cooling/Heating master, the other indoor units automatically become its slaves. For instructions, see "[To set Cooling/Heating masterhood](#)" [[▶ 87](#)].

Status icon

Cooling/Heating masterhood corresponds to the following status icon:



The behaviour of this status icon is according to the following table:

If a controller displays ...	Then ...
... NO status icon	... The indoor unit connected to that controller is Cooling/Heating master.
... a CONSTANT status icon	... The indoor unit connected to that controller is slave to a Cooling/Heating master.
... BLINKING status icon	... NO indoor unit is assigned as Cooling/Heating master yet.

Operation mode

The operation mode behaviour of the indoor units is according to the following table:

If the master ...	Then the slaves ...
... is set to "Heating", "Dry", or "Auto" operation mode	... start running in the same operation mode as the master. No other modes are then available for them.
... is set to "Cooling" operation mode	... then the slaves cannot run in "Heating" operation mode, but can still run in "Cooling", "Fan only" and "Dry" operation mode.
... is set to "Fan only" mode	... can ONLY run in "Fan only" mode.

Once an indoor unit is set as master, it can be released from masterhood. For instructions, see "[To release Cooling/Heating masterhood](#)" [▶ 88]. To turn a slave unit/group into the master, first release the currently active master from its masterhood.



INFORMATION

Ventilation mode changes are possible regardless of Cooling/Heating masterhood.

To set Cooling/Heating masterhood

Prerequisite: No indoor unit is yet set as Cooling/Heating master ("changeover under centralised control" icon blinking on all controllers).

Prerequisite: You are operating the controller of the indoor unit that you want to set as Cooling/Heating master.

- 1 Navigate to the operation mode menu.



- 2 Set the operation mode to either Cooling or Heating.

Result: The indoor unit is now Cooling/Heating master ("changeover under centralised control" icon not on controller).

Result: All slave controllers display the "changeover under centralised control" icon.

To release Cooling/Heating masterhood

Prerequisite: You are in the installer menu.

Prerequisite: You are operating the controller of the indoor unit that you want to release from its masterhood.

- 1 Navigate to the Cooling/Heating masterhood menu.

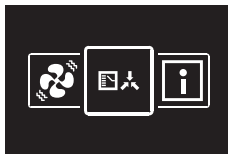

- 2 Press **+** to release the indoor unit from its masterhood.

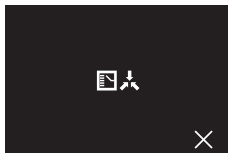

Result: The indoor unit is released from its masterhood.

Result: The controllers of all indoor units display a blinking "changeover under centralised control" icon.

Refrigerant leak alarm test

About refrigerant leak alarm test

It is possible to test the refrigerant leak alarm.

To test the refrigerant leak alarm

Prerequisite: You are in the installer menu.

- 1 Navigate to the refrigerant leak alarm test menu.



- 2 Press **○** to enter the menu and thus activate the alarm.

Result: The controller starts buzzing and the status indicator starts flashing.

Result: The controller displays the following screen:

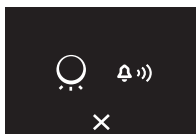

- 3 To stop the alarm again, press **○**.

Result: The alarm stops and the controller returns to the installer menu.



INFORMATION

The refrigerant leak alarm can also be tested using the Madoka Assistant app. See "[Refrigerant leak alarm test](#)" [▶ 123] for more information.

Information

About the information menu

In the information menu, you can see the following information:

To see information

Prerequisite: You are in the installer menu.

- 1 Navigate to the information menu.

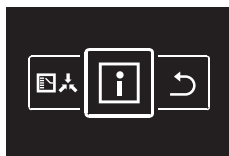

- 2 Read out information.

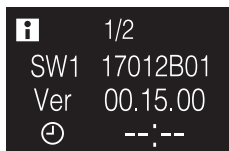

- 3 Press **+** to go to the second page.

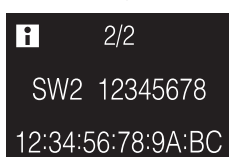

14.2 Software update

14.2.1 About software updates

It is strongly recommended that the remote controller has the latest software version. There are two ways to perform a software update.

Software update	Instructions
Madoka Assistant app	"Software update with app" [▶ 89]
Updating tool	"Software update with updating tool" [▶ 90]



INFORMATION

- When the software of a controller is out-of-date, the Madoka Assistant app will suggest a software update for that controller as soon as you try to connect it (the controller) to the app.
- Checking the current controller software version is possible from the information screen (see "Information screen" [▶ 52]) and/or from the information menu ("About the information menu" [▶ 88]).

14.2.2 Software update with app

To update the software with the app:

- 1 Make sure that Bluetooth is activated on the remote controller ( displayed on the home screen). If not, activate Bluetooth according to the instructions set out in "To make a Bluetooth connection" [▶ 94].
- 2 In the home screen of the app, tap the tile of the remote controller of which you want to update the software, and follow the instruction from there.

**INFORMATION**

The Madoka Assistant app is available from Google Play and the App Store.

**INFORMATION**

When it is the first time you connect a remote controller to your device, app and user interface initiate a numeric comparison procedure. To successfully connect the controller to the app, follow the procedure.

After each successful connection to a mobile device, the controller automatically stores information about that mobile device, this to facilitate future reconnection. This information is called "bonding information".

When no bonding information is stored, (i.e. at first connection, or after it got manually removed), you will have to go through the numeric comparison procedure.

When bonding information is stored, you can connect the controller to the mobile device just by making the controller send out a Bluetooth signal and tapping the tile of the controller in the app. The controller will then connect to the mobile device automatically.

Bonding information gets stored automatically, and can be removed manually. Remove the bonding information from the controller when you want to update the software from another mobile device than the one the controller contains information about.

**INFORMATION**

To connect the remote controller to the mobile device with Bluetooth, and to perform a software update, it is required that you stay close to the remote controller (i.e. within Bluetooth range).

14.2.3 Software update with updating tool

To update the software with Updater

Prerequisite: PC with Updater (contact your dealer for the correct version of the software)

Prerequisite: PC USB cable EKPCAB4 or higher (includes a USB cable and additional connection cables)

- 1 Make sure that the indoor unit is powered OFF.
- 2 Connect the controller to the PC.

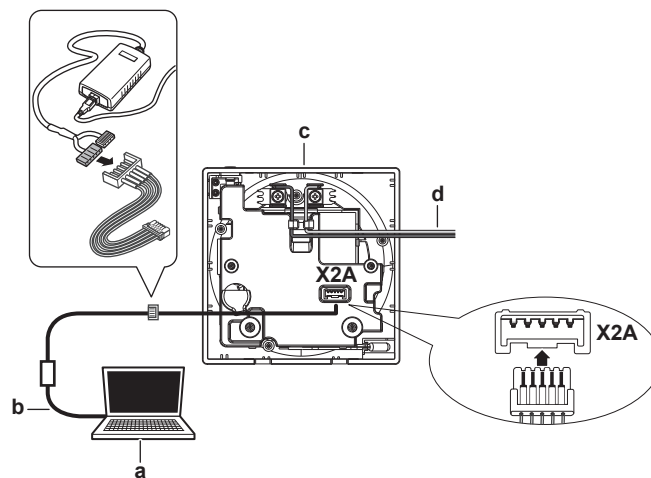

- a PC with Updater
- b USB cable
- c Controller PCB
- d To indoor unit

- 3** Power ON the indoor unit.
- 4** Open Updater.
- 5** In Updater, go to "Update procedure".
- 6** Type in the model name of the controller.
- 7** Select the desired update procedure.
- 8** Follow the on-screen instructions.

15 About the app

The Madoka Assistant app is a companion to the BRC1H remote controller. Where the controller only allows for basic operation and configuration, the app offers advanced operation and configuration functionality.

In this chapter

15.1	Operation and configuration overview	93
15.2	Pairing	93
15.2.1	About pairing	93
15.2.2	To pair the app with a controller	93
15.2.3	To make a Bluetooth connection	94
15.2.4	To terminate the Bluetooth connection	96
15.2.5	To remove bonding information	97
15.3	User access levels	99
15.3.1	About user access levels	99
15.3.2	Basic mode	99
15.3.3	Advanced mode	99
15.3.4	Installer mode	100
15.4	Demo mode	101
15.4.1	About demo mode	101
15.4.2	To launch demo mode	101
15.4.3	To exit demo mode	101
15.5	Functions	101
15.5.1	Overview: Functions	101
15.5.2	Remote controller firmware update	104
15.5.3	Notifications	104
15.5.4	Master/slave status	104
15.5.5	Screen	104
15.5.6	Status indicator	105
15.5.7	Date and time	105
15.5.8	About	106
15.5.9	Remove bonding information	106
15.5.10	Presence detection	106
15.5.11	OFF timer	107
15.5.12	Energy consumption	107
15.5.13	Power consumption limit	107
15.5.14	Setpoint auto reset	107
15.5.15	Schedule	108
15.5.16	Holiday	108
15.5.17	Setpoint logic	109
15.5.18	Setback	110
15.5.19	Individual airflow direction	111
15.5.20	Active airflow circulation	112
15.5.21	Setpoint range	112
15.5.22	Cooling/Heating masterhood	112
15.5.23	Airflow direction range	113
15.5.24	Draught prevention	113
15.5.25	Quick start	113
15.5.26	External input interlock	114
15.5.27	Defrost operation	114
15.5.28	Function lock	114
15.5.29	Quiet mode	116
15.5.30	Errors and warnings	116
15.5.31	Unit number	116
15.5.32	Filter auto clean	117
15.5.33	Filter notifications	117
15.5.34	AirNet address	117
15.5.35	Group address	117
15.5.36	Field settings	118
15.5.37	Duty rotation	119
15.5.38	Test operation	120
15.5.39	Unit status	122
15.5.40	Operating hours	122
15.5.41	Contact information	122
15.5.42	Active airflow circulation	122

15.5.43	Setting migration.....	122
15.5.44	Supervised room address.....	123
15.5.45	Refrigerant leak alarm test.....	123

15.1 Operation and configuration overview

The app continually searches for BRC1H controllers to connect with. All controllers that are in range of your mobile device are listed in the home menu under Nearby Devices. You can also find a list of controllers you have recently interacted with under Recent Devices.

To operate and/or configure the system, tap the tile of the controller that is connected to the indoor units that you want to control.



INFORMATION

In installer mode, the "Recent devices" section is not shown. See "[15.3 User access levels](#)" [p 99] for more information.

15.2 Pairing

15.2.1 About pairing

Before you can actually connect with a controller, you have to make sure that the app and the controller are paired. Pair the app with all the controllers that you want to connect with.

15.2.2 To pair the app with a controller

Prerequisite: You are close to the controller.

- 1 In the app, tap the controller that you want to pair with.

Result: The operating system of your mobile device sends out a pairing request.

Result: The controller displays the following screen:

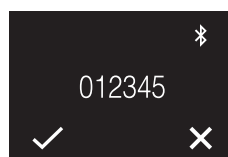

- 2 In the app, accept the pairing request.
- 3 On the controller, accept the pairing request by pressing .

Result: The app is paired with the controller.



INFORMATION

Once paired with the app, the controllers will remain bonded. It is not required to repeat this procedure each time you want to use the app, unless you delete the bonds.

15.2.3 To make a Bluetooth connection

**INFORMATION**

How to make a Bluetooth connection depends on the mode the controller is set to be operable in.

Remote controller mode: "Normal"

Prerequisite: You have a mobile device on which the Madoka Assistant app is installed and running.

Prerequisite: On that mobile device, Bluetooth is turned ON.

Prerequisite: You are close to the remote controller.

- 1 From the home screen, press to enter the main menu.



- 2 Use and to navigate to the Bluetooth menu.



- 3 Press to enter the menu.

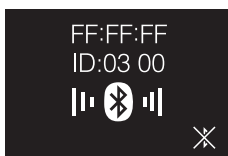

- 4 Press to activate and make the controller send out a Bluetooth signal.

Result:**Numeric comparison**

- 5 In the Madoka Assistant app, tap the tile of the controller of which you want to update the software.

Result: If it is the first time you make a connection, or when bonding information was removed, the operating system of your mobile device sends out a pairing request, including a numeric string.

Result: The controller displays a numeric string, for comparison with that of the pairing request.

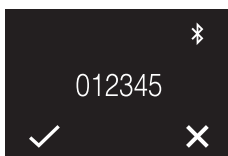

- 6 In the app, accept the pairing request.

- 7 On the controller, press  to confirm the numeric string.

Result: The controller and the mobile device are connected via Bluetooth.

Remote controller modes: "Alarm only" and "Supervisor"

Prerequisite: You have a mobile device on which the Madoka Assistant app is installed and running.

Prerequisite: On that mobile device, Bluetooth is turned ON.

Prerequisite: You are close to the remote controller.

- 1 From the home screen, press  and keep it pressed until the information screen appears.

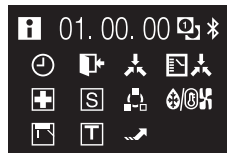

- 2 From the information screen, press  and  simultaneously and keep them pressed until you enter the installer menu.

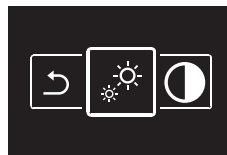

- 3 Use  and  to navigate to the Bluetooth menu.



- 4 Press  to enter the menu.



- 5 Press  to activate  and make the controller send out a Bluetooth signal.

Result:

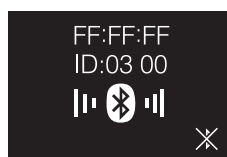

Numeric comparison

- 6 In the Madoka Assistant app, tap the tile of the controller of which you want to update the software.

Result: If it is the first time you make a connection, or when bonding information was removed, the operating system of your mobile device sends out a pairing request, including a numeric string.

Result: The controller displays a numeric string, for comparison with that of the pairing request.

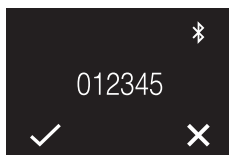

- 7 In the app, accept the pairing request.
- 8 On the controller, press **OK** to confirm the numeric string.

Result: The controller and the mobile device are connected via Bluetooth.

15.2.4 To terminate the Bluetooth connection

i **INFORMATION**
 How to terminate a Bluetooth connection depends on the mode the controller is set to be operable in.

Remote controller mode: "Normal"

- 1 From the home screen, press **OK** to enter the main menu.



- 2 Use **Left** and **Right** to navigate to the Bluetooth menu.



- 3 Press **OK** to enter the menu.

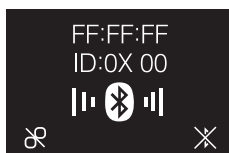

- 4 Press **Left** to stop the remote controller from sending out a Bluetooth signal.

Result:



Remote controller modes: "Alarm only" and "Supervisor"

- 1 From the home screen, press **OK** and keep it pressed until the information screen appears.

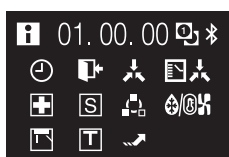

- 2 From the information screen, press **Left** and **OK** simultaneously and keep them pressed until you enter the installer menu.

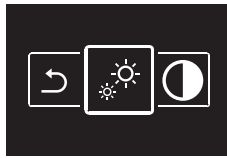

- Use **-** and **+** to navigate to the Bluetooth menu.

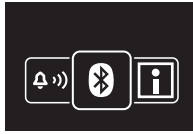

- Press **○** to enter the menu.



- Press **+** to stop the remote controller from sending out a Bluetooth signal.

Result:



15.2.5 To remove bonding information



INFORMATION

How to remove bonding information depends on the mode the controller is set to be operable in.



INFORMATION

Removing the bonding information makes the controller forget all previously bonded mobile devices. When removing the bonding information from a remote controller, also delete the bonding information from your mobile device's Bluetooth list. Failure to do this may result in unsuccessful future bonding.

Remote controller mode: "Normal"

- From the home screen, press **○** to enter the main menu.



- Use **-** and **+** to navigate to the Bluetooth menu.

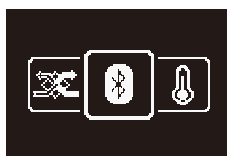

- Press **○** to enter the menu.



- 4 Press to remove the bonding information from the remote controller.

Result:



Remote controller modes: "Alarm only" and "Supervisor"

- 1 From the home screen, press and keep it pressed until the information screen appears.

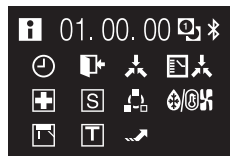

- 2 From the information screen, press and simultaneously and keep them pressed until you enter the installer menu.

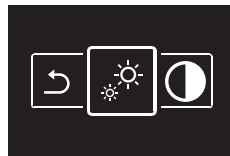

- 3 Use and to navigate to the Bluetooth menu.



- 4 Press to enter the menu.

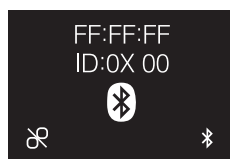

- 5 Press to remove the bonding information from the remote controller.

Result:



15.3 User access levels

15.3.1 About user access levels

The user access level defines which functions and settings are visible to the user of the app. A higher user access level will allow the user to make more in-depth changes to advanced operation and configuration settings. There are 3 possible user access levels that correspond to 3 possible modes:

- Basic
- Advanced
- Installer

15.3.2 Basic mode

This mode allows the user to access all necessary basic settings. This mode is recommended for regular end users. When you first install the app, this mode is enabled by default. To change to a different mode, see "[Advanced mode](#)" [▶ 99] or "[Installer mode](#)" [▶ 100].

15.3.3 Advanced mode

About advanced mode

Advanced mode allows you to make in-depth changes to more advanced operation and configuration settings. Once enabled, you will be able to see and modify settings that, when misconfigured, may harm the working of your device. It is recommended that only advanced users enable this setting. For an overview of which settings can be made in advanced mode, see "[Overview: Functions](#)" [▶ 101].

To activate advanced mode

Prerequisite: You are not in advanced mode.

- 1 Go to the main menu.
- 2 Tap "About".
- 3 Tap "Advanced Settings".
- 4 Tap the switch to toggle on "Advanced Settings".
- 5 Confirm your selection by selecting "I understand" when asked.

Result: Advanced mode is activated. Advanced Settings are visible in the "Unit settings" menu.

To deactivate advanced mode

Prerequisite: You are in advanced mode.

- 1 Go to the main menu.
- 2 Tap "About".
- 3 Tap "Advanced Settings".
- 4 Tap the switch to toggle off "Advanced Settings".

Result: Advanced mode is deactivated. Advanced Settings are no longer visible in the "Unit settings" menu.

15.3.4 Installer mode

About installer mode

In installer mode you have access to settings that are not available for regular end users or advanced users. For an overview of which settings can only be made in installer mode, see "[Overview: Functions](#)" [▶ 101].

To activate Installer mode

Prerequisite: You are not in installer mode.

- 1 Go to the main menu.
- 2 Tap "About".
- 3 Tap "Application version" five times.

Result: You are in the installer mode menu.

Result: Installer mode is automatically activated.

**INFORMATION**

- To continue using the app in installer mode, tap the return button.
- The duration of installer mode depends on installer mode settings. For more information, see "[To make Installer mode settings](#)" [▶ 100].
- There is a visual indication that installer mode is active, which can be disabled. For more information, see "[To make Installer mode settings](#)" [▶ 100].

To deactivate Installer mode

Prerequisite: You are in installer mode.

- 1 Go to the main menu.
- 2 Tap "Installer mode enabled".

Result: You are in the installer mode menu.

Result: Installer mode is automatically activated.
- 3 Deactivate installer mode by tapping the slider.

Result: Installer mode is deactivated.

To make Installer mode settings

- 1 Enable installer mode.

Result: You are in the installer mode menu.
- 2 Make installer mode settings.

Installer mode settings	Description
Installer mode	Enable or disable installer mode.
Temporary / Indefinite	Set the duration of installer mode. <ul style="list-style-type: none"> ▪ Temporary: installer mode active for 30 minutes. After 30 minutes, installer mode will automatically deactivate. (default) ▪ Indefinite: installer mode active until the next manual deactivation.
Installer mode indicator	Set whether installer mode activation is indicated by the installer mode indicator.

**INFORMATION**

Mind that installer mode is automatically enabled as soon as you enter the installer mode menu.

15.4 Demo mode

15.4.1 About demo mode

To try out the app's operation and configuration functions in a safe environment, it is possible to launch a demo version of the app.

15.4.2 To launch demo mode

Prerequisite: You are not in demo mode.

- 1 Go to the main menu.
- 2 Tap "Demo mode".

Result: You are in demo mode.

15.4.3 To exit demo mode

Prerequisite: You are in demo mode.

- 1 Go to the main menu.
- 2 Tap "Exit demo mode".

Result: You exited demo mode.

15.5 Functions

15.5.1 Overview: Functions

**NOTICE**

Depending on the user access level, more or less settings may be visible in the unit settings menu. See "[15.3 User access levels](#)" [▶ 99] for more information about changing modes.

**INFORMATION**

Settings can be saved as favourites by tapping the star symbol in the top-right corner in the menu of a specific setting. These settings are then displayed at the top of the unit settings menu, making them more easily accessible.

Category	Control
Operation	Turn ON/OFF unit operation
	Read out temperature sensor information
	Change the operation mode
	Change the setpoint
	Change the fan speed
	Change the ventilation mode
	Change the ventilation rate
	Change the airflow direction
See notifications	
Configuration and advanced operation	<p>Make controller and indoor unit settings:</p> <p>General</p> <ul style="list-style-type: none"> ▪ Firmware update ▪ Notifications <p>Remote controller settings</p> <ul style="list-style-type: none"> ▪ Master/slave status^(a) ▪ Screen^(a) <ul style="list-style-type: none"> - Home screen setpoint: Numerical or Symbolic ▪ Status indicator^(a) ▪ Date and time^(a) ▪ About ▪ Remove bonding information^(a) <p>Energy saving</p> <ul style="list-style-type: none"> ▪ Presence detection^(a) ▪ OFF timer^(a) ▪ Energy consumption ▪ Power consumption limit^(b) ▪ Setpoint auto reset^(a) <p style="text-align: right;">>> to be continued</p>

^(a) Available in advanced or installer mode only. For more information, see "[Advanced mode](#)" [▶ 99] and "[Installer mode](#)" [▶ 100].

^(b) Available in installer mode only. For more information, see "[Installer mode](#)" [▶ 100].

Category	Control
<< continuation Configuration and advanced operation	<p>Scheduling</p> <ul style="list-style-type: none"> ▪ Schedule ▪ Holiday <p>Configuration and operation</p> <ul style="list-style-type: none"> ▪ Setpoint logic^(a) <ul style="list-style-type: none"> - Single setpoint or Dual setpoint ▪ Setback^(a) ▪ Individual airflow direction^(a) ▪ Active airflow circulation^(a) ▪ Setpoint range^(a) ▪ Cooling/Heating masterhood^(a) ▪ Airflow direction range^(a) ▪ Draught prevention^(a) ▪ Quick start^(a) ▪ Defrost operation^(a) ▪ Function lock^(a) ▪ Quiet mode^(a) ▪ External input interlock^(a) <p>Maintenance</p> <ul style="list-style-type: none"> ▪ Supervised room address^(b) ▪ Errors and warnings^(b) ▪ Unit number^(b) ▪ Filter auto clean^(a) ▪ Filter notifications^(a) ▪ Contact information ▪ AirNet address^(b) ▪ Group address^(b) ▪ Field settings^(b) ▪ Duty rotation^(b) ▪ Test operation^(b) ▪ Unit status^(b) ▪ Operating hours^(b) ▪ Setting migration^(c)

^(a) Available in advanced or installer mode only. For more information, see "[Advanced mode](#)" [▶ 99] and "[Installer mode](#)" [▶ 100].

^(b) Available in installer mode only. For more information, see "[Installer mode](#)" [▶ 100].

^(c) This is a feature that allows you to save and load settings from the one remote controller to the other. It is embedded in certain functions, rather than being a function of itself. For more information, see "[Setting migration](#)" [▶ 122].

15.5.2 Remote controller firmware update

Update remote controller firmware. It is required to keep remote controller firmware up to date. When new firmware is available for a controller, the app will send out a notification in the operation screen of that controller.

To update remote controller firmware

Prerequisite: You are in the operation screen of one of the controllers, and the app notified you that new firmware for that controller is available.

Prerequisite: You are close to the controller.

- 1 Tap the settings icon.

Result: You are in the "Unit settings" menu.

- 2 At the very top, tap "Firmware update available".

Result: You are in the "Firmware update" menu.

- 3 Tap "Update firmware".

Result: The latest firmware is downloaded to the controller.

Result: During the download, the controller displays the following screen.

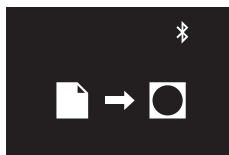

Result: After the download, the controller restarts to implement changes.

15.5.3 Notifications

Get an overview of active system notifications. These can be:

- Errors
- Warnings
- System information

15.5.4 Master/slave status

Find out if the controller you are operating is a master or a slave controller. It is not possible to make changes to master/slave status from the app. For instructions on how to change a controller's master/slave status, see "[11 Starting up the system](#)" [▶ 43].

15.5.5 Screen

Make remote controller screen settings:

Setting	Description
Home screen mode	Set the home screen mode: <ul style="list-style-type: none"> Standard: limited information about system operation (few status icons). Detailed: extensive information about system operation through status icons.
Home screen setpoint	Set how the home screen displays the setpoint: <ul style="list-style-type: none"> Numerical: by way of a numerical value. Symbolic: by way of a symbol. In case "Home screen setpoint " is set to "Symbolic", set the reference setpoints for both Cooling and Heating operation: <ul style="list-style-type: none"> Cooling reference setpoint Heating reference setpoint For more information, see " Home screen setpoint: Symbolic " [▶ 59].
Brightness	Set screen brightness.
Contrast	Set screen contrast.



INFORMATION

When making remote controller screen settings from the app, it is possible that the remote controller does not implement changes immediately. To make the controller implement changes: on the controller, navigate to the installer menu, and then back to the home screen. For instructions on how to enter the installer menu, see "[To enter the installer menu](#)" [▶ 68].

15.5.6 Status indicator

Make remote controller status indicator settings:

Settings	Description
Mode	Check the active status indicator mode. It is not possible to set the status indicator mode from the app; this happens through remote controller field setting R1-11. For more information, see " Remote controller field settings " [▶ 75].
Intensity	Set status indicator intensity.

15.5.7 Date and time

Set the remote controller date and time. In the date and time menu you send date and time information to the remote controller from the app. You can choose to either send the date and time information of your mobile device ("Synchronise with device date and time"), or to manually create and send date and time information.

**INFORMATION**

If the controller is disconnected from the power for more than 48 hours, the date and the time need to be set again.

**INFORMATION**

The clock will maintain accuracy to within 30 seconds/month.

15.5.8 About

Read out the current remote controller and remote controller Bluetooth module software version.

15.5.9 Remove bonding information

Make the controller forget all previously bonded mobile devices.

15.5.10 Presence detection

Set a timer for the system to adjust the temperature setpoint or to turn off automatically, based on (the lack of) presence detected by a motion sensor.

Action	Description
Auto OFF	Set an OFF timer that starts running as soon as the motion sensor detects the room is unoccupied.
Setpoint adjustment	Set setpoint adjustment increments and intervals for both heating and cooling operation. When the motion sensor detects the room is unoccupied, the system will raise (cooling operation) or lower (heating operation) the setpoint, until the set limit is reached.

**INFORMATION**

To use this function, it is required that the indoor units are equipped with a motion sensor (optional accessory).

**INFORMATION**

This function cannot be used when the indoor units are controlled by a centralised controller.

**INFORMATION**

This function is not supported when the system contains Sky Air RR or RQ outdoor units.

**INFORMATION**

This function cannot be used when the indoor units are in group control.

**INFORMATION**

For systems in which the indoor units run in simultaneous operation, this function is controlled by the motion sensor mounted in the master indoor unit.

15.5.11 OFF timer

Set a timer for the system to turn OFF automatically. The timer can be enabled or disabled. When the timer is enabled, it starts running each time the system gets turned ON.

The timer has a range of 30~180 minutes, and can be set in increments of 30 minutes.

15.5.12 Energy consumption

See and compare energy consumption data.

**INFORMATION**

The availability of this function depends on the type of indoor unit.

**INFORMATION**

This function cannot be used when the indoor units are in group control.

**INFORMATION**

This function is not supported when the system contains Sky Air RR or RQ outdoor units.

**INFORMATION**

The displayed energy consumption can be different from the actual energy consumption. The displayed data is not the result of a kWh measurement, but the result of a calculation based on measured operation data. Some of that operation data are absolute values, but some are interpolations, including room for interpolation tolerance.

15.5.13 Power consumption limit

Set a timespan in which the system limits its peak power consumption. When enabled, this function makes the outdoor unit operate with limited energy consumption (70% or 40% of usual consumption) in the set timespan.

**INFORMATION**

The availability of this function depends on the type of outdoor unit.

15.5.14 Setpoint auto reset

Set a timer for the system to automatically adjust the temperature to a set temperature value. The timer can be enabled or disabled for Heating and Cooling operation separately. When a timer is enabled, it starts running each time the system gets turned ON. When the timer runs out, the temperature setpoint will always change to the set value, also if the temperature setpoint has been changed in the meanwhile.

The timer has a range of 30~120 minutes, and can be set in increments of 30 minutes.



INFORMATION

This function cannot be used when the indoor units are controlled by a centralised controller.

15.5.15 Schedule

Organise system actions into schedules. The schedule function allows you to set up to 5 timed actions for each day of the week. It is possible to create up to 3 different schedules, though only 1 schedule can be active at the same time.

The action logic is as follows:

- 1 Set a timespan for the action.
- 2 Choose to turn system operation ON or OFF, and set the conditions.

IF "Operation"	THEN
ON	Set action-specific temperature setpoints for Cooling and/or Heating operation, or choose to maintain the current setpoints.
OFF	Choose to enable or disable Setback operation for Cooling and/or Heating operation. If enabled, set action-specific Setback setpoints, or choose to maintain the current setpoints. For more information, see "Setback" [▶ 110] .



INFORMATION

If the "Home screen setpoint" setting is set to "Symbolic", there is only a limited range of possible temperature setpoints. However, if "Home screen setpoint" is set to "Symbolic", and there is a setpoint change coming from a schedule, then the system will disregard the regular setpoint limitations and allow the schedule to exceed the limited setpoint range. For more information, see ["Home screen setpoint: Symbolic" \[▶ 59\]](#).



INFORMATION

This function cannot be used when the indoor units are controlled by a centralised controller.



INFORMATION

This function cannot be used when digital input adapter BRP7A5* is part of the system.

15.5.16 Holiday

Select days of the week for which the schedule does not apply. On the selected days, any actions set with the schedule function do not get executed. The holiday function can be enabled or disabled. When enabled, it applies to any schedule that is set to be active.

**INFORMATION**For more information, see "[Schedule](#)" [▶ 108].

15.5.17 Setpoint logic

Set up the setpoint logic. Choose whether the setpoint logic is executed by the indoor unit, or by the remote controller.

Setpoint logic	Description
Indoor unit	The setpoint logic is executed by the indoor unit.
Remote controller	The setpoint logic is executed by the remote controller.

In case of remote controller setpoint logic, choose whether to have single setpoint logic, or dual setpoint logic.

Remote controller setpoint logic	Description
Single setpoint	There is only one temperature setpoint, independent of the operation mode. If this is the case, changing the operation mode does NOT change the setpoint. Or the other way around, if you change the setpoint, you do so for both Cooling and Heating operation.
Dual setpoint	There are two temperature setpoints: one specifically for Cooling operation, and one specifically for Heating operation. If this is the case, changing the operation mode DOES change the setpoint (i.e. to the setpoint of the other operation mode). Or the other way around, if you change the Cooling setpoint, you do NOT change the Heating setpoint.

In case of dual setpoint logic, set the Minimum setpoint differential. This is the minimum difference between the possible setpoints for Cooling and Heating operation:

- Cooling setpoint \geq (Heating setpoint + Minimum setpoint differential)
- Heating setpoint \leq (Cooling setpoint – Minimum setpoint differential)

This means that:

- If you lower the Cooling setpoint $<$ (Heating setpoint + Minimum setpoint differential), then the controller will automatically lower the Heating setpoint.
- If you raise the Heating setpoint $>$ (Cooling setpoint – Minimum setpoint differential), then the controller will automatically raise the Cooling setpoint.

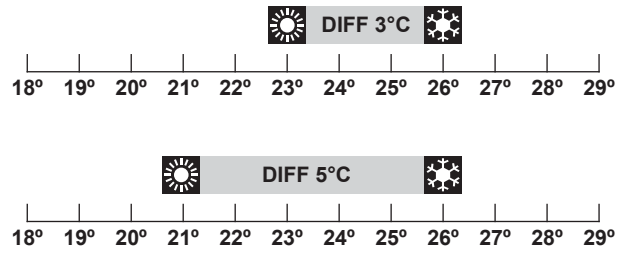

DIFF Minimum setpoint differential

i **INFORMATION**
 When the system is controlled by central control equipment, control of the system by the controller is limited. When this is the case, it is not possible to set dual setpoint logic in the Madoka Assistant app.

i **INFORMATION**
 When the indoor units are under control of a centralised controller, only indoor unit setpoint logic is possible.

i **INFORMATION**
 In case of indoor unit setpoint logic, the system cannot run in Auto operation mode. To enable Auto operation mode for VRV heat pump systems, go for remote controller setpoint logic.

15.5.18 Setback

Enable Setback temperature control. Setback is a function that keeps the room temperature in a specific range when the system is turned off (by the user, the schedule function, or the OFF timer). To achieve this, the system temporarily runs in Heating or Cooling operation mode, according to the setback setpoint and recovery differential.

Example:

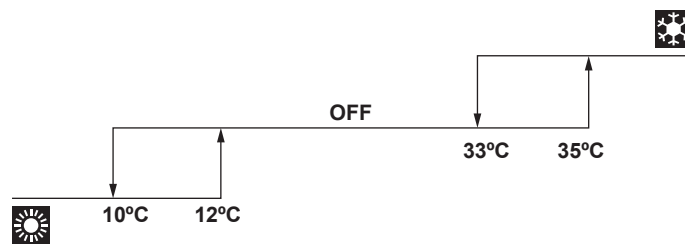

Settings		Result
Heating operation 	Heating setback setpoint	10°C
	Heating recovery differential	+2°
		If the room temperature drops below 10°C, the system automatically starts heating operation. If after 30 minutes the temperature rises above 12°C, the system stops heating operation, and turns off again. When the room temperature drops below 10°C again, the process gets repeated.

Settings			Result
Cooling operation 	Cooling setback setpoint	35°C	If the room temperature rises above 35°C, the system automatically starts cooling operation. If after 30 minutes the temperature drops below 33°C, the system stops cooling operation, and turns off again. When the room temperature rises above 35°C again, the process gets repeated.
	Cooling recovery differential	-2°C	

**INFORMATION**

- Setback is by default enabled.
- Setback turns on the system for at least 30 minutes, unless the setback setpoint is changed, or the system is turned on with the ON/OFF button.
- When Setback is active, you cannot make changes to fan speed settings.
- When Setback activates while the system is set to Auto operation mode, the system will switch to Cooling or Heating operation mode, depending on which is required. The Setback setpoint displayed on the operation screen is then according to the operation mode.
- When Setback is active and the "Home screen setpoint" setting is set to "Symbolic", then there is no indication of Setback operation on the remote controller home screen.

**INFORMATION**

This function cannot be used when the indoor units are controlled by a centralised controller.

**INFORMATION**

The default setpoint range limits for Setback operation are [33°C-37°C] for Cooling operation, and [10°C-15°C] for Heating operation. It is not possible to change these limits.

15.5.19 Individual airflow direction

Set the airflow direction of each individual indoor unit air outlet. The maximum number of indoor units for which you can make these settings depends on the type of system:

System	Maximum number of indoor units
Sky Air	4
VRV	16

Of cassette-type indoor units, it is possible to identify the individual air outlets by way of the following indicators:

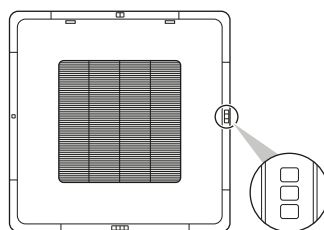

**INFORMATION**

The availability of this function depends on the type of indoor unit.

15.5.20 Active airflow circulation

Enable Active airflow circulation to have a more even temperature distribution in the room.

When Active airflow circulation is enabled, indoor unit fan speed and airflow direction get controlled automatically, making manual fan speed and airflow direction changes impossible.

15.5.21 Setpoint range

Set a limitation to the temperature setpoint range of both Cooling and Heating operation.

**INFORMATION**

This function cannot be used when the indoor units are controlled by a centralised controller.

**INFORMATION**

The default setpoint range limits for both Heating and Cooling operation is [16°C-32°C], regardless of whether or not "Setpoint range limitation" is enabled. It is not possible to exceed these limits.

**INFORMATION**

The lower setpoint limit of the Cooling operation mode is 20°C, as per UAE Federal regulation UAE.S 5010-5:2016 clause 6, and UAE.S 5010-1:2016 clause 10.

**INFORMATION**

The upper setpoint limit of the Heating operation mode is 28°C, as per Egypt regulation.

15.5.22 Cooling/Heating masterhood

Set an indoor unit (or group of indoor units) as Cooling/Heating master. When multiple indoor units are connected to an outdoor unit, one of these units (or a group of indoor units, in case of group control) needs to be set as Cooling/Heating master. The other units/groups then become Cooling/Heating slaves, and are restricted in their operation by the master (e.g. one outdoor unit does not allow for one indoor unit to run in Cooling operation while another runs in Heating operation).

When an indoor unit or group of indoor units is set as Cooling/Heating master, the other units/groups automatically become its slaves. To turn a slave unit into the master, first connect the app to the controller controlling the currently active master and release it from its masterhood, then set the (slave) unit as master.

15.5.23 Airflow direction range

Set the indoor unit airflow direction range according to the installation location. This function is available for floorstanding indoor units only. The maximum number of indoor units for which you can make these settings is 16.

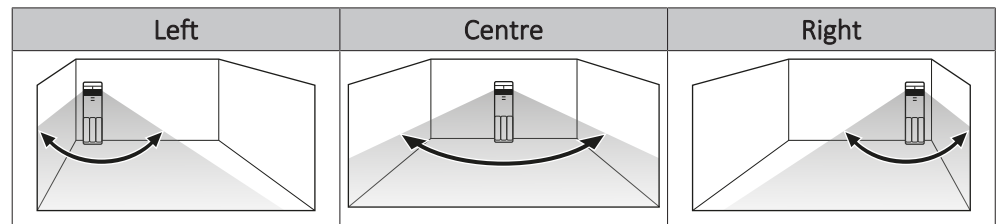

The ranges correspond with the following airflow swing patterns:

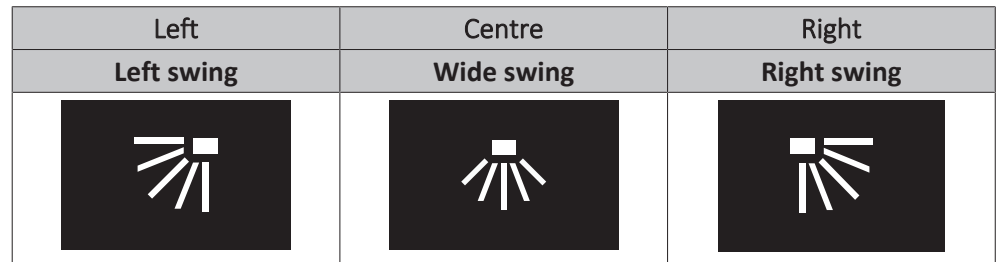

INFORMATION

The availability of this function depends on the type of indoor unit.



INFORMATION

For systems in which the indoor units run in simultaneous operation, it is possible to set the airflow direction range of individual indoor units by connecting the controller to each indoor unit separately.

15.5.24 Draught prevention

Prevent people from getting affected by indoor unit airflow, based on (the lack of) presence detected by a motion sensor.



INFORMATION

To use this function, it is required that the indoor units are equipped with a motion sensor (optional accessory).



INFORMATION

This function is not supported when the system contains Sky Air RR or RQ outdoor units.

15.5.25 Quick start

Activate Quick start to quickly bring the room to a comfortable temperature.

When Quick start is active, the outdoor unit operates with increased capacity. Indoor unit fan speed gets controlled automatically, making manual fan speed changes impossible.

After activation, Quick start is active up to 30 minutes. After 30 minutes, Quick start automatically deactivates, and the system resumes normal operation. Additionally, Quick start will deactivate from the moment you change the operation mode manually.

Quick start can ONLY be activated when the system is running in Cooling, Heating, or Auto operation mode.

**INFORMATION**

This function is only available for Sky Air indoor units.

**INFORMATION**

This function is not supported when the system contains Sky Air RR or RQ outdoor units.

15.5.26 External input interlock

External input interlock allows for the integration of external contacts in the system's control logic. By adding a key card contact and/or a window contact to the control setup, it is possible to have the system respond to the insertion/removal of a key card in/from a card reader, and/or the opening/closing of windows.

For more information, see "[About external input interlock](#)" [▶ 81].

**INFORMATION**

To use this function, it is required that digital input adapter BRP7A5* is part of the system.

- Make sure that the digital input adapter and its optional contacts (window contact B1 and key card contact B2) are correctly installed. Confirm that the voltage free contact of the digital input adapter is in the correct position. For instructions on how to install the digital input adapter, see the installation manual of the digital input adapter.
- When the digital input adapter does not function properly, external input interlock is not available in the menu.
- When the digital input adapter is part of the system, the system does not allow for the connection of a slave controller.
- When the digital input adapter is part of the system, it is not possible to use the Schedule function.
- When the digital input adapter is part of the system, as well as a centralised controller, the external input interlock function is controlled by the centralised controller, and not by the adapter.

15.5.27 Defrost operation

Make the system run in defrost operation mode, this to prevent the loss of heating capacity due to frost accumulation in the outdoor unit.

**INFORMATION**

The system will return to normal operation after approximately 6 to 8 minutes.

15.5.28 Function lock

Make functions and operation modes unavailable by locking them. It is possible to lock the following functions and operation modes:

Remote controller	▪ Menu button
-------------------	---------------

Functions	<ul style="list-style-type: none"> ▪ Setpoint ▪ Fan speed ▪ Operation mode ▪ Airflow direction ▪ System ON/OFF ▪ Setpoint range ▪ Setback ▪ Presence sensor - Setpoint adjustment ▪ Presence sensor - Auto OFF ▪ Setpoint adjustment timer ▪ OFF timer ▪ Power consumption limit ▪ Schedule ▪ Filter auto clean ▪ Date and time ▪ Draught prevention ▪ Airflow direction range ▪ Duty rotation ▪ External input interlock ▪ Individual airflow direction ▪ Ventilation rate ▪ Ventilation mode
Operation modes	<ul style="list-style-type: none"> ▪ Automatic ▪ Cooling ▪ Heating ▪ Fan ▪ Dry ▪ Ventilation





INFORMATION

- When you lock an operation mode that is active at the moment of locking, that mode will still be active upon saving settings and leaving the menu. Only when you change the operation mode, that mode will not be available anymore.
- When you lock ALL operation modes, it will not be possible to switch to an operation mode other than the one that is active at the moment of locking.

Remote controller

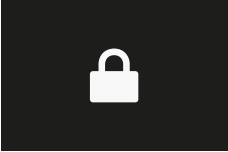
Locking functions and operation modes from the app results in changes on the remote controller.

Operation	Remote controller
Home screen	<p>When you lock functions/buttons that are operated from the controller home screen, the controller will display a lock screen when you try to use these functions/buttons.</p> 
Main menu	<p>When you lock functions that are main menu items on the controller, these functions get crossed out in the main menu, and accompanied by a lock icon.</p>  <p>When locking operation modes, the controller simply omits them from the operation mode menu.</p>

15.5.29 Quiet mode

Set a timespan in which the outdoor unit operates more quietly.



INFORMATION

The availability of this function depends on the type of outdoor unit.

15.5.30 Errors and warnings

Consult the error history, and temporarily enable/disable the pushing of error and/or warning notifications.

The pushing of error and warning notifications is by default enabled. Disable "Display errors" and "Display warnings" to prevent the system from pushing error and warning notifications for 48 hours. After 48 hours, "Display errors" and "Display warnings" become automatically enabled again.

15.5.31 Unit number

Change the unit number of the indoor unit(s). To configure individual indoor units, these units require a unit number. The unit number of an indoor unit is its ranking in the list. To give a unit a new unit number, change its ranking by either moving it to an empty slot, or switching it with another indoor unit. If you need help identifying physical indoor units, tap an indoor unit's fan icon to make that indoor unit's fan operate.

15.5.32 Filter auto clean



INFORMATION

To use this function, it is required that the indoor units are equipped with a self-cleaning decoration panel (optional accessory).

Enable automatic indoor unit filter cleaning operation and set a timespan for it.

Reset dustbox maintenance timer

When it is time to empty the self-cleaning decoration panel's dustbox, the app displays a notification in the operation screen. Empty the dustbox and reset the notification.

15.5.33 Filter notifications

Dismiss notification

The app displays a notification in the operation screen when it is time to perform one of the following filter-related maintenance activities:

- Replacement of indoor unit filter.
- Cleaning of indoor unit filter.
- Cleaning of indoor unit element.

Perform the required maintenance, then dismiss the notification.



INFORMATION

For more information on indoor unit maintenance, see the operation manual of the indoor unit.

Reset notification timer

Filter maintenance due time is controlled by timers. The app sends out a maintenance notification each time a timer expires. It is possible to reset these timers.



INFORMATION

To use this function, it is required that you use the app in installer mode. For instructions on how to activate installer mode, see "[Installer mode](#)" [▶ 100].

15.5.34 AirNet address

Assign AirNet addresses to the indoor and outdoor units, this to connect the system to the AirNet monitoring and diagnostics system. First select a unit by way of its unit number, then assign it an AirNet address.

15.5.35 Group address

Assign addresses to the indoor units, this to control the system with central control equipment. You can assign an address to the group of indoor units connected to the controller, and to indoor units individually.

15.5.36 Field settings

Make indoor unit and remote controller field settings. For an overview of possible field settings, see "[Indoor unit field settings](#)" [▶ 73] and "[Remote controller field settings](#)" [▶ 75].

Setting procedure

Field settings are composed of the following components:

- Modes
- Units
- Settings
- Values

The field settings procedure differs depending on whether you are making settings for individual indoor units or for groups of indoor units, or for the remote controller.

Field settings type	Procedure
Individual indoor units	<ul style="list-style-type: none"> ▪ Set the field setting type to "Indoor unit". ▪ Define a mode. In the field settings table, find this number between brackets in the Mode column. ▪ Define the unit to which the setting will apply by setting a unit number. ▪ Define the setting by tapping the right tile in the app. In the field settings table, find settings in the SW column. ▪ Define a value for that setting.
Groups of indoor units	<ul style="list-style-type: none"> ▪ Set the field setting type to "Indoor unit". ▪ Define a mode. In the field settings table, find this number NOT between brackets in the Mode column. ▪ Do NOT set a unit number (the settings will apply to all units in the group). ▪ Define the setting by tapping the right tile in the app. In the field settings table, find settings in the SW column. ▪ Define a value for that setting.
Remote controller	<ul style="list-style-type: none"> ▪ Set the field setting type to "Remote controller". ▪ Define a mode. ▪ Define the setting by tapping the right tile in the app. In the field settings table, find settings in the SW column. ▪ Define a value for that setting.

Default values

Field setting default values are different depending on the indoor unit model. For more information, see the service manual of the indoor units. For the following field settings, the default values are the same for all indoor unit models:

Field setting	Default value
Thermostat sensor	02
Setback	04
Window contact B1	02
Key card contact B2	02
Airflow direction range	02
Remote controller thermostat sensor	02
Rotation overlap time	03



INFORMATION

- The connection of optional accessories to the indoor unit might cause changes to some field settings. For more information, see the installation manual of the optional accessory.
- For details about the specific field settings of each type of indoor unit, see the installation manual of the indoor units.
- Outdoor unit field settings can only be configured via the outdoor unit PCB. For more information, see the installation manual of the outdoor unit.
- Field settings that are not available for a connected indoor unit are not displayed.

15.5.37 Duty rotation

Activate Duty rotation to let the indoor units operate alternately (one indoor unit alternately inactive), this to increase system lifespan and reliability.

Duty rotation is designed for units operating in critical applications (e.g. in server rooms that require lots of cooling). In these cases, the system is equipped with an extra backup unit. Activating Duty rotation then allows for:

- **Rotation:** because the system is equipped with more units than are required to provide the heating/cooling load, one of the units can remain inactive during normal operation. After a set time (i.e. "Rotation cycle time"), the inactive unit will start operation, and a previously active unit will become inactive (i.e. duty rotation). Because the units only operate alternately, the lifespan of the system increases.
- **Backup:** having a backup unit allows for system redundancy. If an active unit goes into error, Duty rotation makes sure an inactive one takes over.

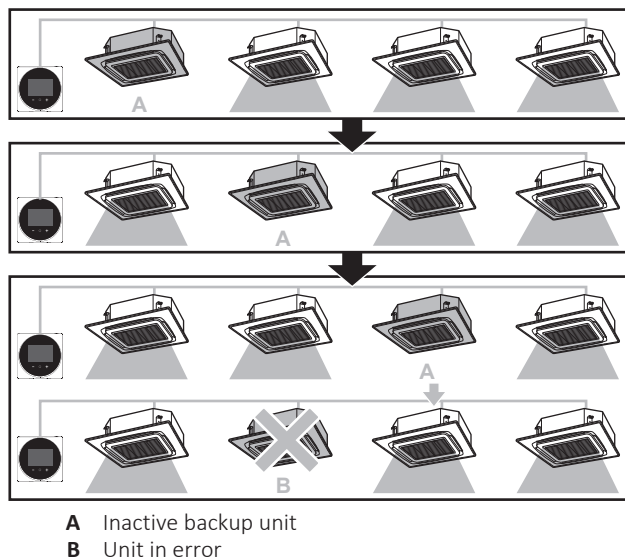
**INFORMATION**

This function can only be used when the indoor units are in group control.

**INFORMATION**

- To let the backup unit reach its cooling/heating capacity, an overlap period is included in which all indoor units are active. For more information, see "[Indoor unit field settings](#)" [▶ 73] (cfr. field setting 1E-7).
- The rotation order depends on the set unit number. For instructions on how to change the indoor units' unit number, see "[Unit number](#)" [▶ 116].

15.5.38 Test operation

Perform an indoor unit test operation. During the test run, the indoor units cycle through various operation modes and functions to check if they are ready for operation.

When

Only activate the test operation after the following is completed:

- Installation of refrigerant piping;
- Installation of drain piping;
- Connection of electrical wiring.

Typical workflow

Performing a test operation typically consists of the following stages:

- 1 Activating the test operation (Madoka Assistant app),
- 2 Testing the indoor unit functions according to the instructions set out in "[To perform a test operation](#)" [▶ 121],
- 3 Deactivating the test operation (Madoka Assistant app),
- 4 Checking the error history for possible errors.
- 5 If applicable, fixing the causes of those errors.
- 6 Repeating the procedure if required.

**INFORMATION**

This function is only available for Sky Air indoor units.

**INFORMATION**

Also see the installation manual of the indoor unit and outdoor unit.

Precautions when performing a test operation**CAUTION**

Before starting up the system, make sure:

- The indoor and outdoor unit wiring is completed.
- The switch box covers of the indoor and outdoor units are closed.

**NOTICE**

Be sure to turn ON the power 6 hours before operation in order to have power running to the crankcase heater and to protect the compressor.

**INFORMATION**

After the installation of the refrigerant piping, drain piping, and electrical wiring, make sure to clean the inside of the indoor unit, as well as the decoration panel.

To perform a test operation

- 1 Confirm that the indoor unit gas and liquid stop valves are open.

**INFORMATION**

It is possible that the pressure inside the refrigerant circuit does not rise, despite the opened stop valve. This can be due to the expansion valve (or the like) blocking the refrigerant, and does not obstruct the test run.

- 2 Open the Madoka Assistant app.
- 3 Navigate to the operation screen of the controller that is connected to the indoor unit(s) on which you want to perform a test run.
- 4 In the operation screen, set the operation mode to Cooling.
- 5 Go to the "Unit settings" menu (upper right corner of the operation screen).
Result: You are in the "Unit settings" menu.
- 6 In the "Maintenance field", tap "Test operation".
Result: You are in the "Test operation" menu.
- 7 Tap "Start test operation".
Result: The indoor unit(s) enter test operation mode, during which normal operation is not possible.
- 8 Return to the operation screen.
- 9 Tap "Vertical airflow direction".
- 10 Tap "Fixed".
- 11 Cycle through the five fixed airflow directions, and confirm if the indoor unit flaps behave correspondingly.
- 12 Return to the "Test operation" menu.
- 13 Tap "Stop test operation".
Result: The indoor units leave test operation mode. Normal operation is possible again.

- 14 Go to "[13 Operation](#)" [▶ 50] and confirm if the indoor unit(s) behave according to the information set out there.
- 15 Check the error history. If required, solve the cause of the errors and perform the test operation again.

**INFORMATION**

The test operation finishes after 30 minutes.

15.5.39 Unit status

With Unit status, you can:

- Information retrieval: enter a code to make the system retrieve specific information about an indoor or outdoor unit component. First select a unit by way of its unit number, then enter the code to start the information retrieval.
- Indoor unit: see information provided by various sensors that are present in the system. First select a unit by way of its unit number.

**INFORMATION**

The **information retrieval** function is only present in the menu when you use the app in installer mode. For instructions on how to activate installer mode, see "[Installer mode](#)" [▶ 100].

15.5.40 Operating hours

Monitor indoor and outdoor unit operating hours.

15.5.41 Contact information

Enter the phone number of the system's service contact.

15.5.42 Active airflow circulation

Enable Active airflow circulation to have a more even temperature distribution in the room.

When Active airflow circulation is enabled, indoor unit fan speed and airflow direction get controlled automatically, making manual fan speed and airflow direction changes impossible.

15.5.43 Setting migration

Some functions allow you to save settings to your mobile device, and load them to other remote controllers. This is useful in case you have to make the same settings for multiple controllers.

When you are finished making settings on one controller, choose to save them to your mobile device. After saving, connect the app to another controller, go to the applicable setting, and tap "Load configuration".

The following Madoka Assistant app functions allow you to save and load settings:

- Schedule
- Setback
- Setpoint range

- Field settings
- Power consumption limit

15.5.44 Supervised room address

Assign a unique supervised room address to individual indoor units. It is mandatory to set a unique supervised room address for every indoor unit when the remote controller is set to "Supervisor" mode. First select an indoor unit by way of its unit number, then assign a unique supervised room address to it. If the supervised room address is not set, alarms will not be communicated to the remote controller in "Supervisor" mode.

To set the supervised room address in the Madoka Assistant app, navigate to R32 refrigerant settings in the Maintenance section under Unit settings. Then, tap Supervised room address to manage the supervised room address of the indoor units.

15.5.45 Refrigerant leak alarm test

The refrigerant leak alarm can be tested using the Madoka Assistant app.

- 1** In the app, navigate to R32 refrigerant settings in the Maintenance section under Unit settings.
- 2** Tap R32 refrigerant system settings.
- 3** Tap Test alarm and blinking LED to test the refrigerant leak alarm.
Result: The refrigerant leak alarm starts.
- 4** Tap Stop testing alarm and blinking LED to stop the alarm.

Result: The refrigerant leak alarm stops.

16 Maintenance

In this chapter

16.1	Maintenance safety precautions.....	124
16.2	About maintenance	124
16.3	To remove a warning screen	126
16.4	To clean the controller	126
16.5	Time to clean filter indication	126
16.5.1	To remove the Time to clean filter indication	126

16.1 Maintenance safety precautions



WARNING

Before carrying out any maintenance or repair activities, stop system operation with the controller, and turn off the power supply circuit breaker. **Possible consequence:** electric shock or injury.



NOTICE

To clean the controller, do NOT use organic solvents, such as paint thinner. **Possible consequence:** damage, electric shock, or fire.



WARNING

Do not wash the remote controller. **Possible consequence:** electric leakage, electric shock, or fire.





INFORMATION

When the dirt on the surface cannot be removed easily while cleaning the controller, soak the cloth in neutral detergent diluted with water, squeeze the cloth tightly, and clean the surface. Afterwards, wipe dry with a dry cloth.

16.2 About maintenance

When an indoor unit component needs maintenance, the controller displays  on the home screen, and generates a warning screen. Go to the warning screen to see which component needs maintenance, perform the maintenance, and remove the warning screen.

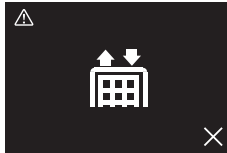
The following warning screens are related to indoor unit maintenance:

<p>Clean the indoor unit filter</p> 	<p>Replace the indoor unit filter</p> 
<p>Empty the indoor unit dustbox</p> 	<p>—</p>

The procedure to see the warning screen is different depending on the set status indicator mode (i.e. "Normal", "Hotel 1", or "Hotel 2").



INFORMATION

By default, the controller is in status indicator mode "Hotel 2".

Status indicator mode: "Normal"

Prerequisite: The controller displays the home screen, and  is visible, indicating maintenance.

- 1 Press .

Result: The controller displays the warning screen.





Status indicator mode: "Hotel 1" and "Hotel 2"

Prerequisite: The controller displays the home screen, and  is visible, indicating maintenance.

- 2 Press  and keep it pressed.

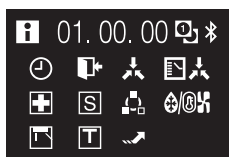
Result: The controller displays the information screen.



- 3 Press  and keep it pressed.

Result: The controller displays the warning screen.





16.3 To remove a warning screen

Prerequisite: The controller displays the home screen, and  is visible, indicating maintenance.

- 1 Go to the warning screen.



- 2 Solve the cause of the warning screen.
- 3 Press  to remove the warning screen.

Result: The controller returns to the home screen. If the cause of the warning was properly solved,  has disappeared.



INFORMATION

The procedure to see the warning screen is different depending on the set status indicator mode (i.e. "Normal", "Hotel 1", or "Hotel 2"). For more information, see ["16.2 About maintenance" \[▶ 124\]](#).

16.4 To clean the controller

- 1 Wipe the screen and other surface parts of the controller with a dry cloth.

16.5 Time to clean filter indication

When the indoor unit filter is dirty and needs to be cleaned, the controller will indicate this by displaying  in the top left corner of the home screen, and confronting you with the 'Time to clean filter' screen as soon as you try to enter the main menu from the home screen.

16.5.1 To remove the Time to clean filter indication

Prerequisite: On trying to enter the main menu from the home screen, you are confronted with the 'Time to clean filter' screen.





- 1 Clean the filter.
- 2 Press  to remove the 'Time to clean filter' indication.

17 Troubleshooting

In this chapter

17.1	Error codes of the indoor unit.....	127
17.2	Refrigerant leak detection.....	129
17.2.1	About refrigerant leak detection	129
17.2.2	To stop the leak detection alarm.....	129

17.1 Error codes of the indoor unit

When the system is in error, the controller displays  on the home screen, and generates an error screen. Go to the error screen to see the error code, solve the cause of the error, and press  to remove the error screen. For a list of error codes and their meaning, see the documentation of the indoor unit.

The procedure to see the error screen is different depending on the set status indicator mode (i.e. "Normal", "Hotel 1", or "Hotel 2").



INFORMATION

By default, the controller is in status indicator mode "Hotel 2".

Status indicator mode: "Normal"

Prerequisite: The controller displays the home screen, and  is visible, indicating error.

- 1 Press .

Result: The controller displays the error screen.

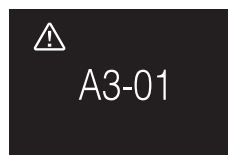

Status indicator mode: "Hotel 1" and "Hotel 2"

Prerequisite: The controller displays the home screen, and  is visible, indicating error.

- 2 Press  and keep it pressed.

Result: The controller displays the information screen.

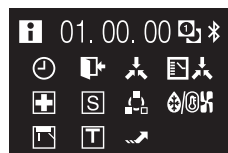

- 3 Press  and keep it pressed.

Result: The controller displays the error screen.

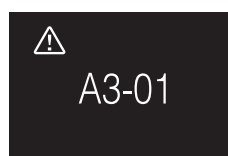

**INFORMATION**

If the controller is set to be operable in "Supervisor" mode, then the controller adds the "supervised room address" of the faulty indoor unit to the error screen. In "Supervisor" mode, it is mandatory to set a unique "supervised room address" for every indoor unit. The "supervised room address" can be set in the Madoka Assistant app. Note that in case of multiple leakages, only the address of the first faulty unit rising the error is displayed.

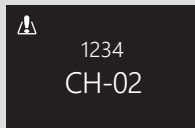

For more information about the modes the controller can be set to be operable in, see "[12.1 About the controller](#)" [▶ 45].



17.2 Refrigerant leak detection

When the system detects a refrigerant leak, an alarm goes off on the controller, and the Madoka Assistant app sends out a notification. Stop the alarm and dismiss the notification.

17.2.1 About refrigerant leak detection

The information that the controller displays in case of a refrigerant leak depends on the mode that the controller is set to be operable in.

Normal and Alarm only mode

Master controller	Slave controller
The controller displays the unit number of the leaking indoor unit	The controller does not display the unit number of the leaking indoor unit
	

Supervisor mode

Master controller	Slave controller
—	The controller displays the supervised room address of the leaking indoor unit
	



INFORMATION

For more information about the modes, see "[12.1 About the controller](#)" [▶ 45].

17.2.2 To stop the leak detection alarm

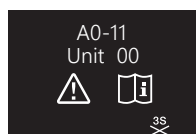

- 1 Press **+** for 3 seconds to stop the alarm.

Result: The alarm stops.

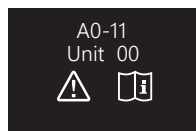

- 2 Fix the refrigerant leak of the unit.



INFORMATION

In case the controller is set to be operable in 'Supervisor' mode, the controller will indicate the supervised room address of the indoor unit for which the leak detection alarm occurs. However, it is not possible to stop the alarm of the indoor unit controller (set to be operable in either "Normal" or "Alarm only" mode) from the controller in "Supervisor" mode. The alarm of the controller connected to the indoor unit with the leak has to be stopped individually.

18 Technical data

A **subset** of the latest technical data is available on the regional Daikin website (publicly accessible). The **full set** of latest technical data is available on the Daikin Business Portal (authentication required).

18.1 Connection diagram

18.1.1 Typical layout

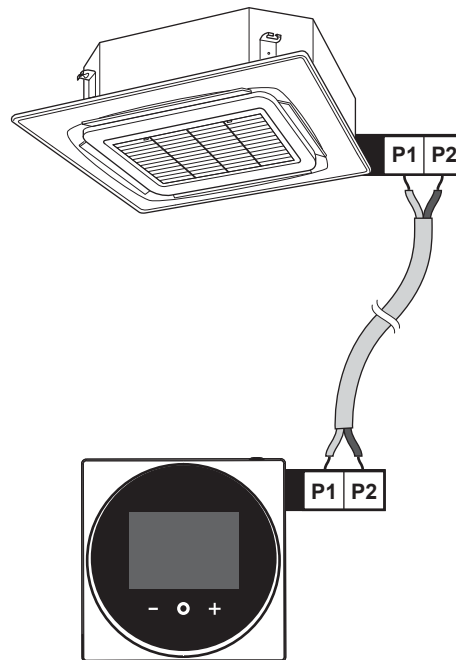

18.1.2 Typical layout for group control



INFORMATION

In case of a system that includes units with R32 refrigerant, group control of the indoor units is not possible.

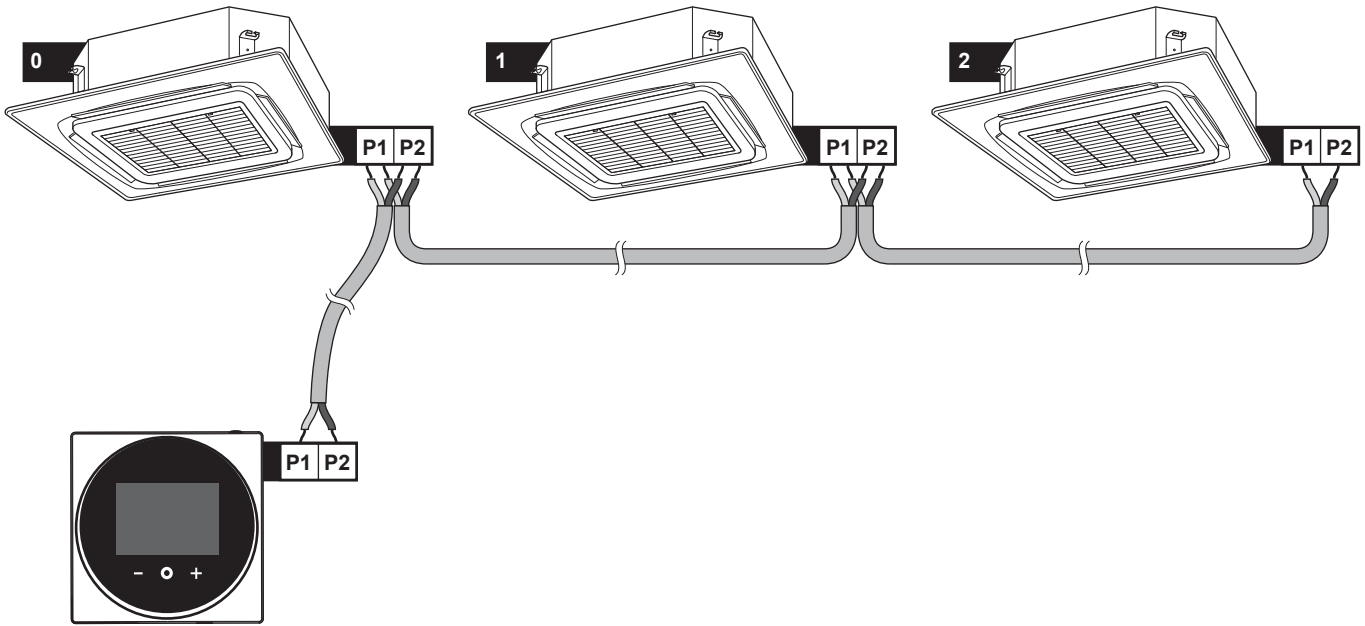

Group control: master and slave controller

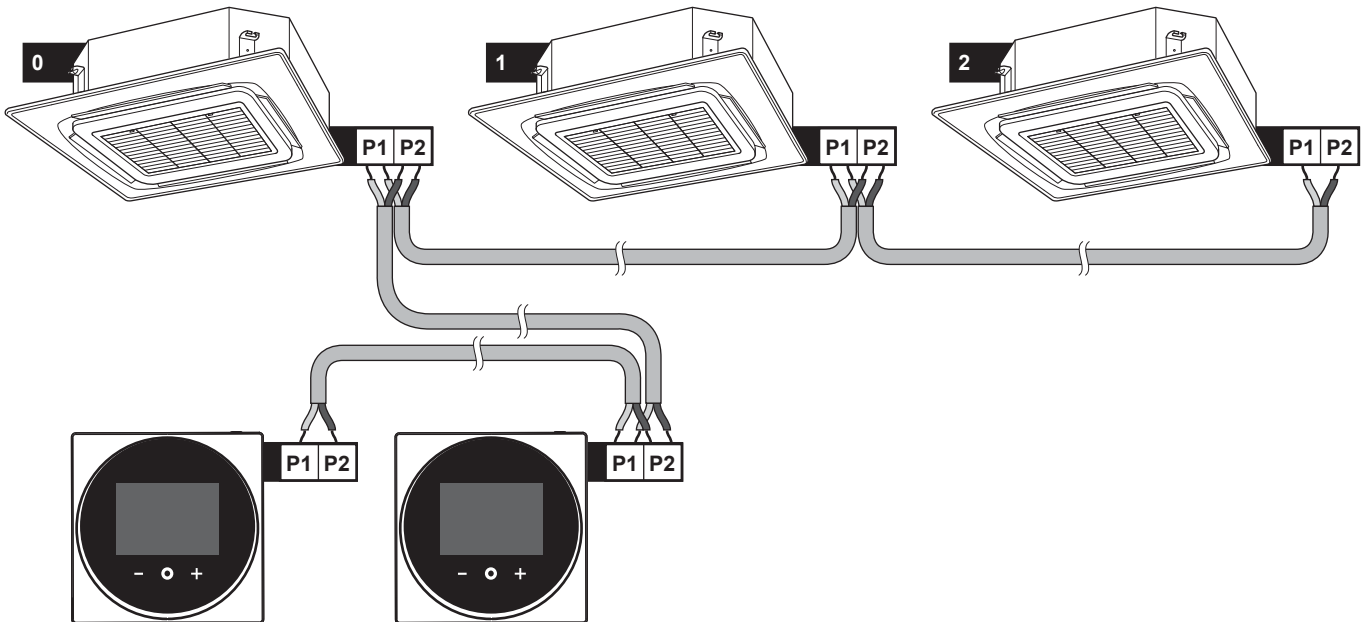

Group control: controller + digital inputs adapter BRP7A5

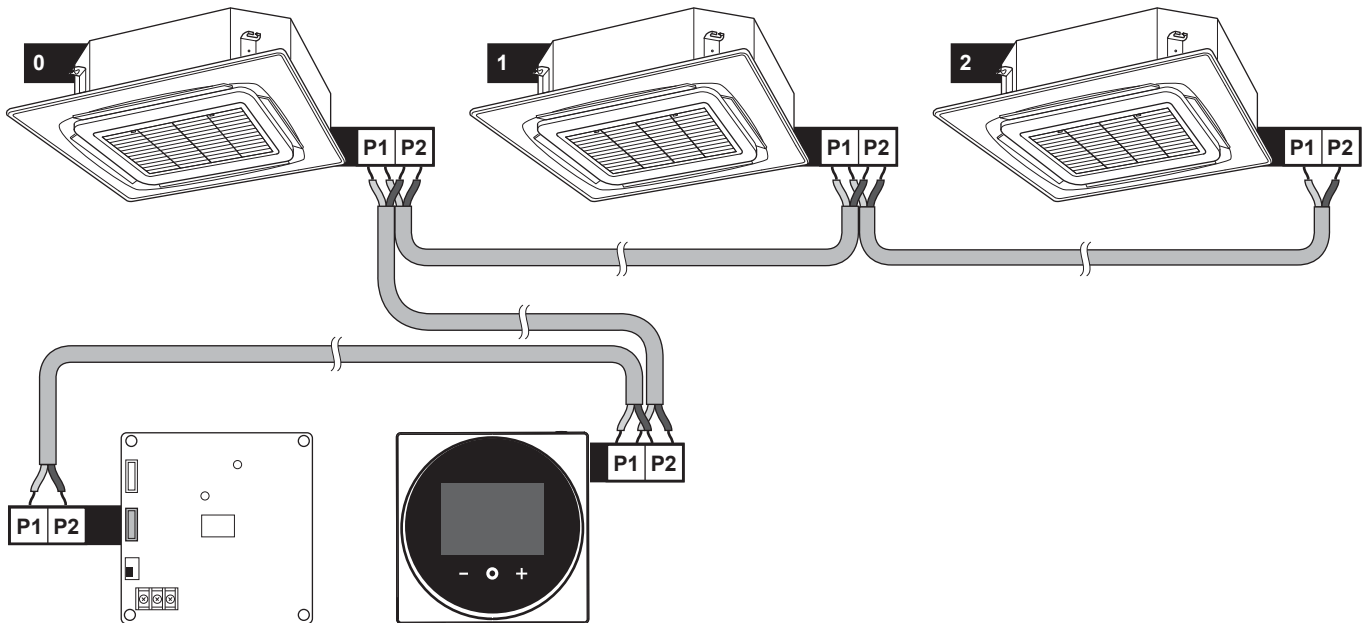

18.1.3 Controller + DIII central control equipment

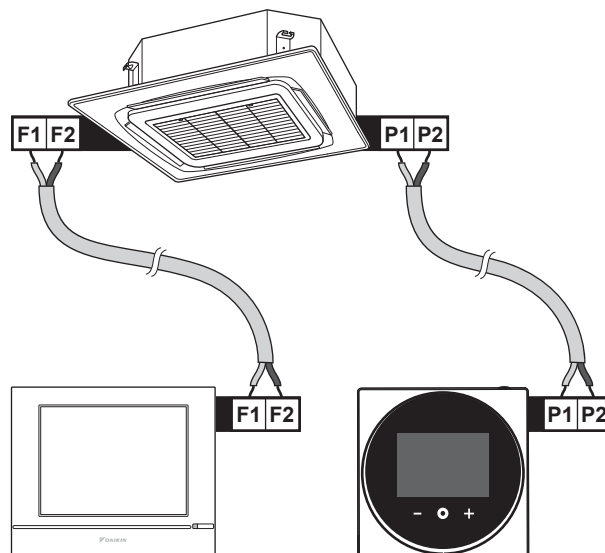

19 Glossary

DHW = Domestic hot water

Hot water used, in any type of building, for domestic purposes.

LWT = Leaving water temperature

Water temperature at the water outlet of the unit.

Dealer

Sales distributor for the product.

Authorised installer

Technical skilled person who is qualified to install the product.

User

Person who is owner of the product and/or operates the product.

Applicable legislation

All international, European, national and local directives, laws, regulations and/or codes that are relevant and applicable for a certain product or domain.

Service company

Qualified company which can perform or coordinate the required service to the product.

Installation manual

Instruction manual specified for a certain product or application, explaining how to install, configure and maintain it.

Operation manual

Instruction manual specified for a certain product or application, explaining how to operate it.

Accessories

Labels, manuals, information sheets and equipment that are delivered with the product and that need to be installed according to the instructions in the accompanying documentation.

Optional equipment

Equipment made or approved by Daikin that can be combined with the product according to the instructions in the accompanying documentation.

Field supply

Equipment NOT made by Daikin that can be combined with the product according to the instructions in the accompanying documentation.

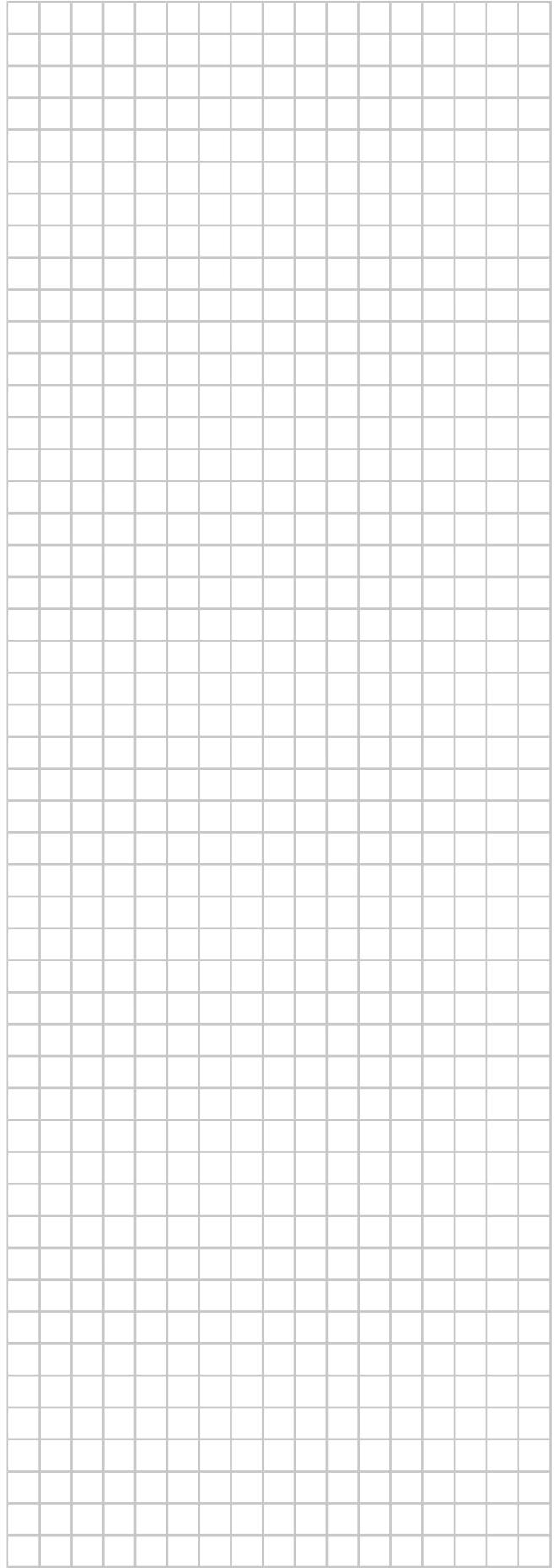

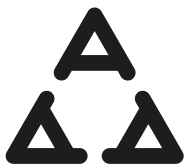

V005 18

